



www.simaaksesuar.com

 **SIMA**
Furniture Accessories

www.simaaksesuar.com

Köprü Damalı

Kod / SM-1010

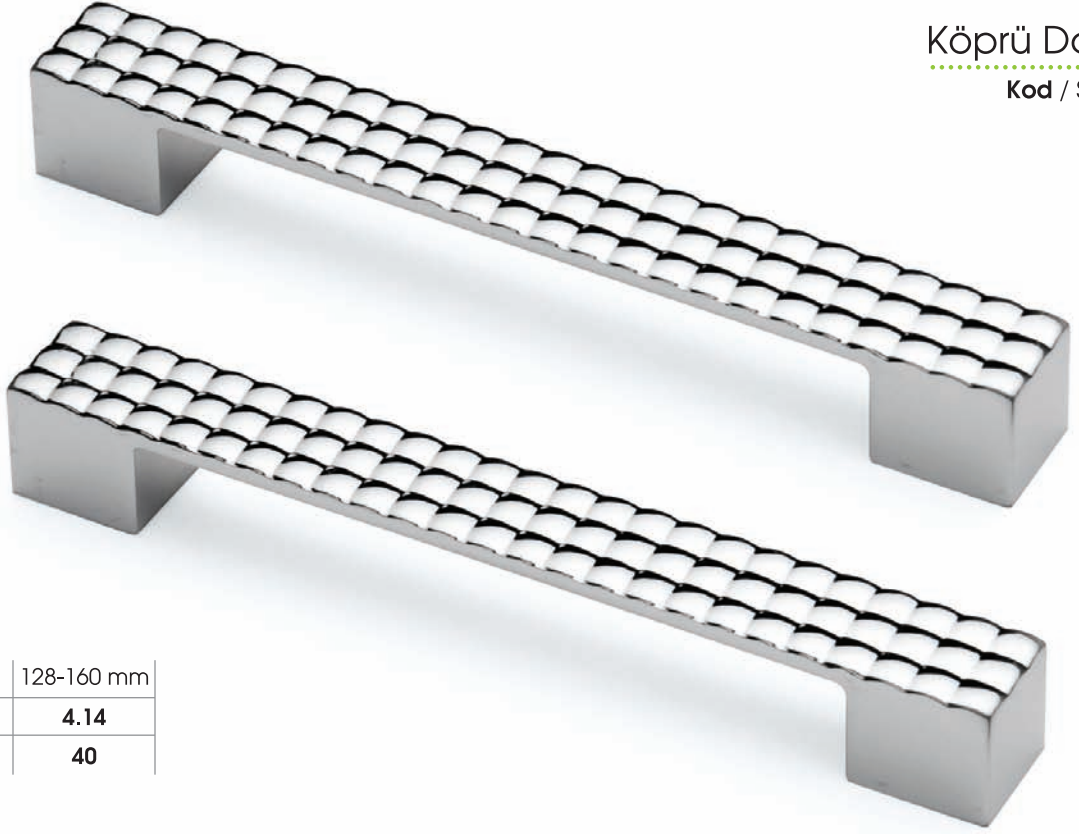

Boy	128-160 mm
Krom	4.14
	40

Köprü Baklavalı

Kod / SM-1011

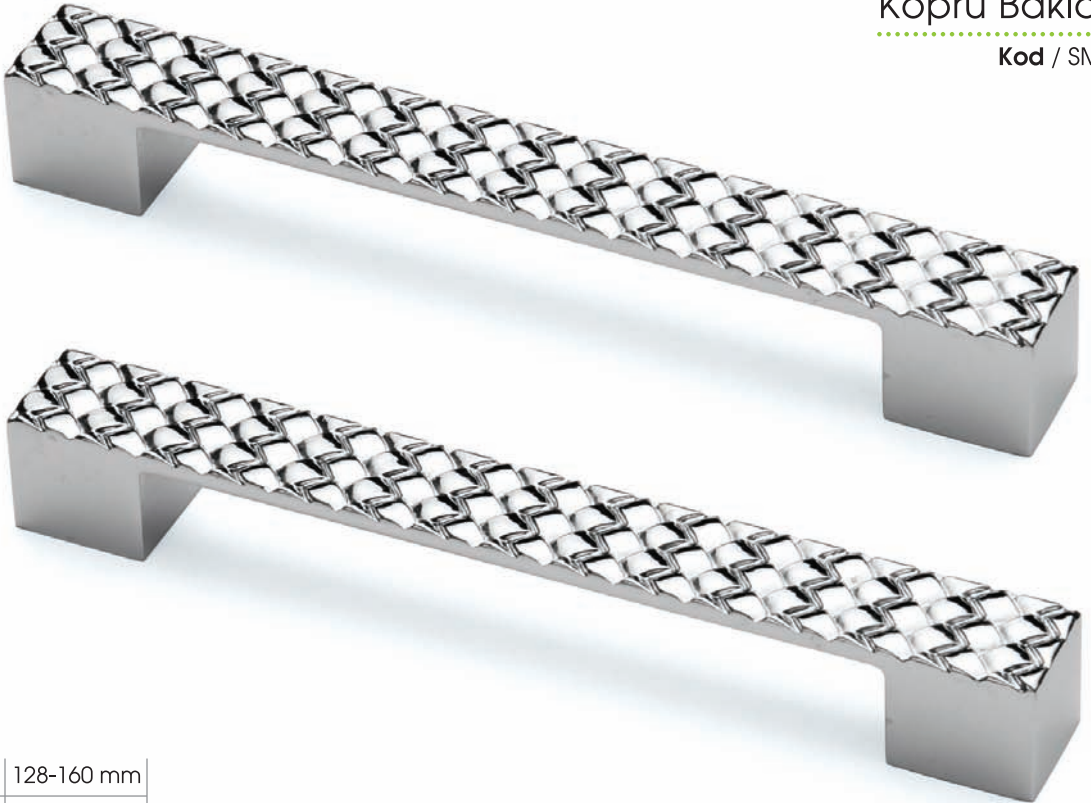

Boy	128-160 mm
Krom	4.14
	40

İtir Kulp

Kod / SM-1012

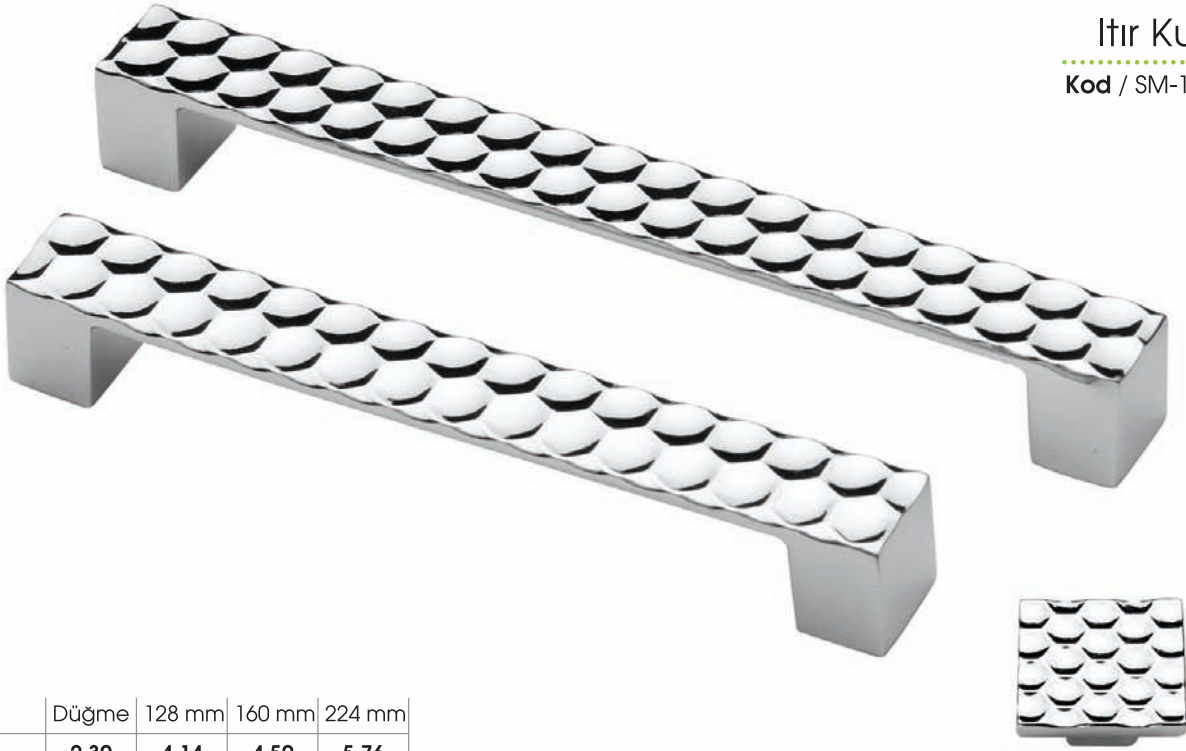

Boy	Düğme	128 mm	160 mm	224 mm
Krom	2.39	4.14	4.59	5.76
	50	50	40	40

Mercan Kulp

Kod / SM-1013

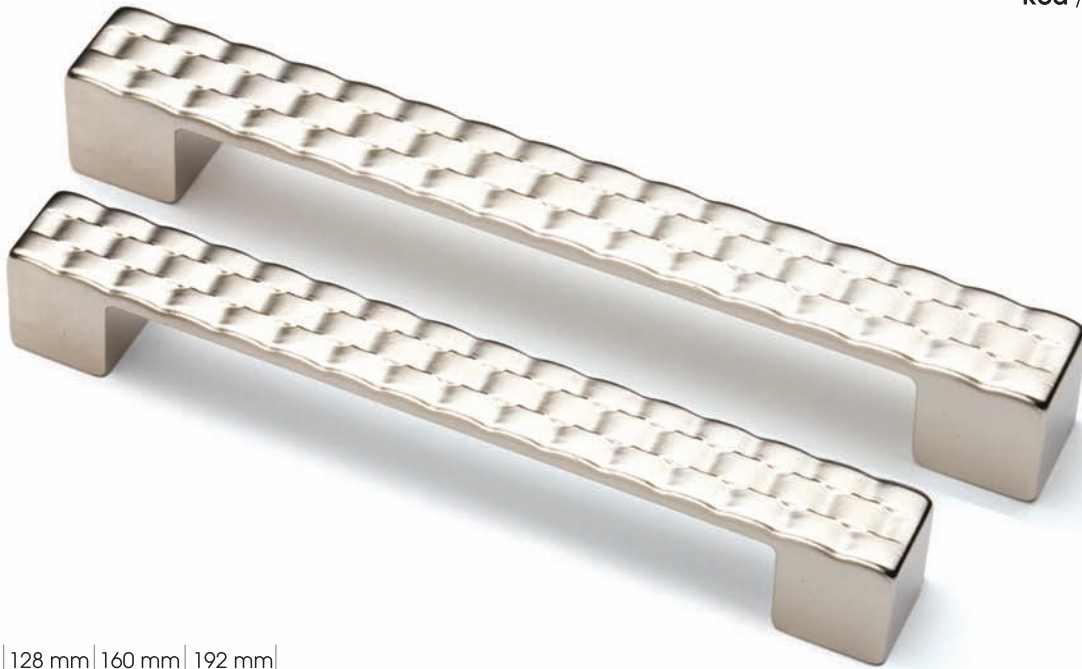

Boy	128 mm	160 mm	192 mm
Krom	5.00	5.48	6.44
Saten	5.00	5.48	6.44
	50	50	50

Şahin Kulp

Kod / SM-1014



Boy	128 mm	160 mm	192 mm	224 mm	256 mm	288 mm	320 mm	352 mm	416 mm
Krom	4.82	5.36	5.91	6.30	6.93	7.55	8.10	9.23	10.43
inox	5.40	5.94	6.48	6.97	7.58	8.18	8.77	10.32	11.61
☐	50	50	40	40	40	40	40	40	40

Şahin Şeritli Kulp

Kod / SM-1015



Boy	128 mm	160 mm	192 mm	224 mm	256 mm	288 mm	320 mm	352 mm	416 mm
Şeritli	5.40	5.94	6.48	6.97	7.58	8.18	8.77	10.32	11.61
☐	50	50	40	40	40	40	40	40	40

Mali Çizgili Kulp

Kod / SM-1016



Boy	128 mm	160 mm	192 mm	224 mm	256 mm	288 mm	320 mm
Krom	3.42	3.99	4.47	5.17	5.76	6.30	6.90
inox	3.78	4.41	4.95	5.71	6.47	7.15	7.74
	50	50	50	50	50	50	50

Mali Düz Kulp

Kod / SM-1017



Boy	128 mm	160 mm	192 mm	224 mm	256 mm	288 mm	320 mm
Krom	3.42	3.99	4.47	5.17	5.76	6.30	6.90
inox	3.78	4.41	4.95	5.71	6.47	7.15	7.74
	50	50	50	50	50	50	50

Ekol Kulp

Kod / SM-1018



Boy	128 mm	160 mm	192 mm	224 mm	256 mm	288 mm	320 mm
Krom	3.42	3.99	4.47	5.17	5.76	6.30	6.90
Krom inox	3.78	4.41	4.95	5.71	6.47	7.15	7.74
📦	50	50	50	50	50	50	50

Lama Kulp

Kod / SM-1019



Boy	128 mm	160 mm	192 mm	224 mm	256 mm	288 mm	320 mm	352 mm	416 mm
Krom	3.69	4.23	4.70	5.45	6.14	6.68	7.38	8.10	9.54
inox	4.14	4.86	5.39	6.21	6.93	7.56	8.33	9.18	11.10
📦	50	50	40	40	40	40	40	40	40

Işıl Kulp

Kod / SM-1020



Boy	128 mm	160 mm	192 mm	224 mm	256 mm	288 mm	320 mm	352 mm	416 mm
Krom	4.23	4.73	5.22	5.76	6.30	6.75	7.38	8.28	9.90
inox	4.77	5.27	5.67	6.30	6.75	7.29	7.88	8.91	10.80
	50	50	40	40	40	40	40	40	40

Yay Kulp

Kod / SM-1021



Boy	128 mm	160 mm	192 mm	224 mm	256 mm	288 mm	320 mm
Krom	3.60	4.32	4.95	5.67	6.30	7.11	7.92
inox	4.05	4.77	5.58	6.30	7.02	7.74	8.64
	50	50	50	50	50	50	50

idil Kulp

Kod / SM-1022



Boy	128 mm	160 mm	192 mm	224 mm	256 mm	288 mm	320 mm
Krom	3.59	4.22	4.86	5.53	6.21	6.84	7.49
inox	4.04	4.67	5.40	6.19	6.95	7.61	8.28
	50	50	50	50	50	50	50

Volga Kulp

Kod / SM-1023



Boy	128 mm	160 mm	192 mm	224 mm	256 mm	288 mm	320 mm	352 mm	416 mm
Krom	3.60	4.19	4.82	5.58	6.21	6.98	7.56	8.42	10.26
inox	4.04	4.68	5.40	6.32	7.02	7.56	8.37	9.54	11.61
	50	50	50	50	50	50	50	50	50

Göze Çizgili Kulp

Kod / SM-1024



Boy	128 mm	160 mm	192 mm	224 mm	256 mm	288 mm	320 mm	352 mm	416 mm
Krom	4.82	5.36	5.91	6.30	6.93	7.55	8.10	9.23	10.43
inox	5.40	5.94	6.48	6.97	7.58	8.18	8.77	10.32	11.61
	50	50	40	40	40	40	40	40	40

Göze Düz Kulp

Kod / SM-1025



Boy	128 mm	160 mm	192 mm	224 mm	256 mm	288 mm	320 mm	352 mm	416 mm
Krom	4.82	5.36	5.91	6.30	6.93	7.55	8.10	9.23	10.43
inox	5.40	5.94	6.48	6.97	7.58	8.18	8.77	10.32	11.61
	50	50	40	40	40	40	40	40	40

Yalı Çizgili Kulp

Kod / SM-1026



Boy	128 mm	160 mm	192 mm	224 mm	256 mm	288 mm	320 mm
Krom	4.82	5.36	5.91	6.30	6.93	7.55	8.10
inox	5.40	5.94	6.48	6.97	7.58	8.18	8.77
	50	50	50	50	50	50	50

Yalı Düz Kulp

Kod / SM-1027



Boy	128 mm	160 mm	192 mm	224 mm	256 mm	288 mm	320 mm
Krom	4.82	5.36	5.91	6.30	6.93	7.55	8.10
inox	5.40	5.94	6.48	6.97	7.58	8.18	8.77
	50	50	50	50	50	50	50

Feza Kulp

Kod / SM-1028



Boy	128 mm	160 mm	192 mm	224 mm	256 mm	288 mm	320 mm
Krom	4.82	5.36	6.03	6.30	6.93	7.55	8.10
inox	5.40	5.94	6.48	6.97	7.58	8.18	8.78
	50	50	40	40	40	40	40

Sude Kulp

Kod / SM-1029



Boy	128 mm	160 mm	192 mm	224 mm	256 mm	288 mm	320 mm	352 mm	416 mm
Krom	4.82	5.36	5.91	6.30	6.93	7.55	8.10	9.23	10.43
inox	5.40	5.94	6.48	6.97	7.58	8.18	8.77	10.32	11.61
	50	50	40	40	40	40	40	40	40

Saray Kulp

Kod / SM-1030



Boy	128 mm	160 mm	192 mm	224 mm	256 mm	288 mm	320 mm
Krom	4.92	5.49	6.05	6.52	7.08	7.75	8.32
inox	5.51	6.07	6.62	7.13	7.73	8.39	8.95
📦	50	50	40	40	40	40	40

Kavis Kulp

Kod / SM-1031



Boy	96 mm	128 mm	160 mm	192 mm	224 mm	256 mm	288 mm	320 mm	352 mm	416 mm	512 mm
Krom	3.60	4.05	4.73	5.40	6.08	6.66	7.20	7.88	8.55	9.90	12.60
inox	4.05	4.50	5.31	6.08	6.75	7.29	7.92	8.78	9.63	11.61	15.30
📦	50	50	50	40	40	40	40	40	40	40	40

Orkide Kulp

Kod / SM-1032



Boy	96 mm	128 mm	160 mm	192 mm	224 mm	256 mm	288 mm	320 mm	352 mm	416 mm	512 mm	608 mm
Krom	2.61	2.97	3.33	3.73	4.17	4.61	5.07	5.51	6.21	7.89	10.71	14.26
inox	3.10	3.45	3.81	4.20	4.73	5.21	5.67	6.21	6.92	9.31	13.08	17.81
	75	50	50	40	40	40	40	40	40	40	40	40

Fulya Kulp

Kod / SM-1033



Boy	Düğme	64 mm	96 mm	128 mm	160 mm	192 mm	224 mm	256 mm	288 mm	320 mm	352 mm	416 mm	512 mm	608 mm
Krom	1.80	2.03	2.25	2.48	2.81	3.05	3.33	3.60	4.05	4.50	4.86	5.67	6.66	7.65
inox	2.03	2.25	2.48	2.81	3.24	3.50	3.78	4.14	4.61	5.18	5.58	6.75	8.46	9.81
	150	100	75	50	50	50	50	50	50	50	50	50	50	50

T Kulp
Kod / SM-1034



Boy	96 mm	128 mm	160 mm	192 mm	224 mm	256 mm	288 mm	320 mm	352 mm	416 mm	512 mm
Krom	2.48	3.15	3.60	4.14	4.59	5.04	5.58	6.12	7.02	7.92	10.80
☐	75	50	50	50	50	50	50	50	50	50	50

Mali Kuyruklu Çizgili Kulp
Kod / SM-1035



Boy	224 - 10 cm	224 - 20 cm	224 - 30 cm	224 - 40 cm	224 - 50 cm
Krom	7.20	7.74	9.90	12.15	15.03
☐	50	50	50	50	50

Mali Kuyruklu Düz Kulp

Kod / SM-1036



Boy	224 - 10 cm	224 - 20 cm	224 - 30 cm	224 - 40 cm	224 - 50 cm
Krom	7.20	7.74	9.90	12.15	15.03
	50	50	50	50	50

İdil Kuyruklu Kulp

Kod / SM-1037



Boy	224 - 10 cm	224 - 20 cm	224 - 30 cm	224 - 40 cm	224 - 50 cm
Krom	7.43	8.01	10.17	12.42	15.30
inox	8.33	9.04	11.97	14.67	22.05
	50	50	50	50	50

Milas Çizgili Kulp

Kod / SM-1038

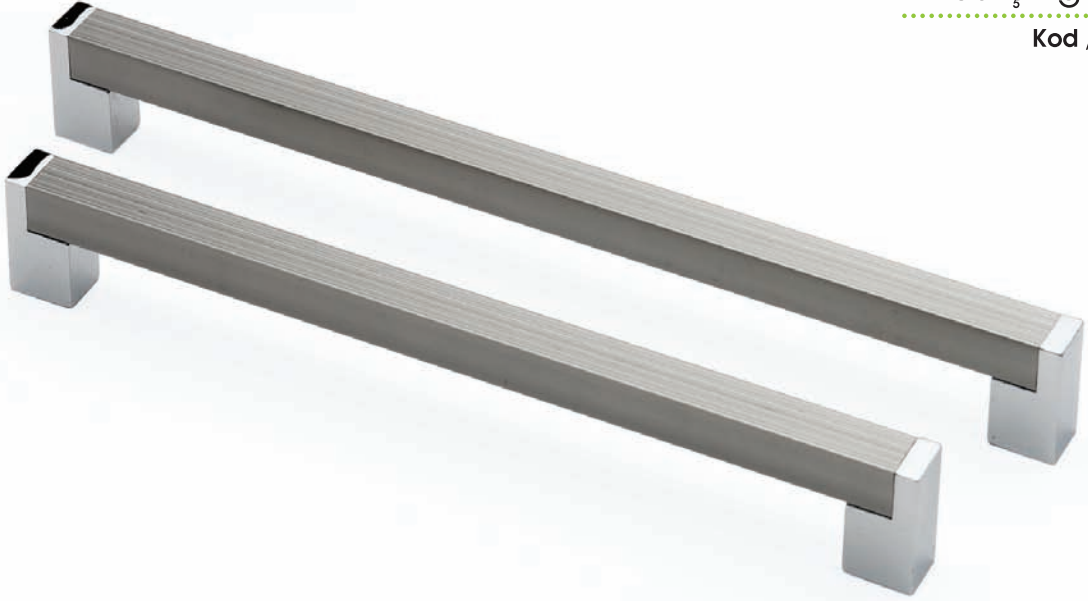

Boy	96 mm	128 mm	160 mm	192 mm	224 mm	256 mm	288 mm	320 mm	352 mm	416 mm
Krom inox	1.89	2.03	2.16	2.30	2.43	2.57	2.70	2.97	3.24	3.60
☒	50	50	50	40	40	40	40	40	40	40

Milas Düz Kulp

Kod / SM-1039

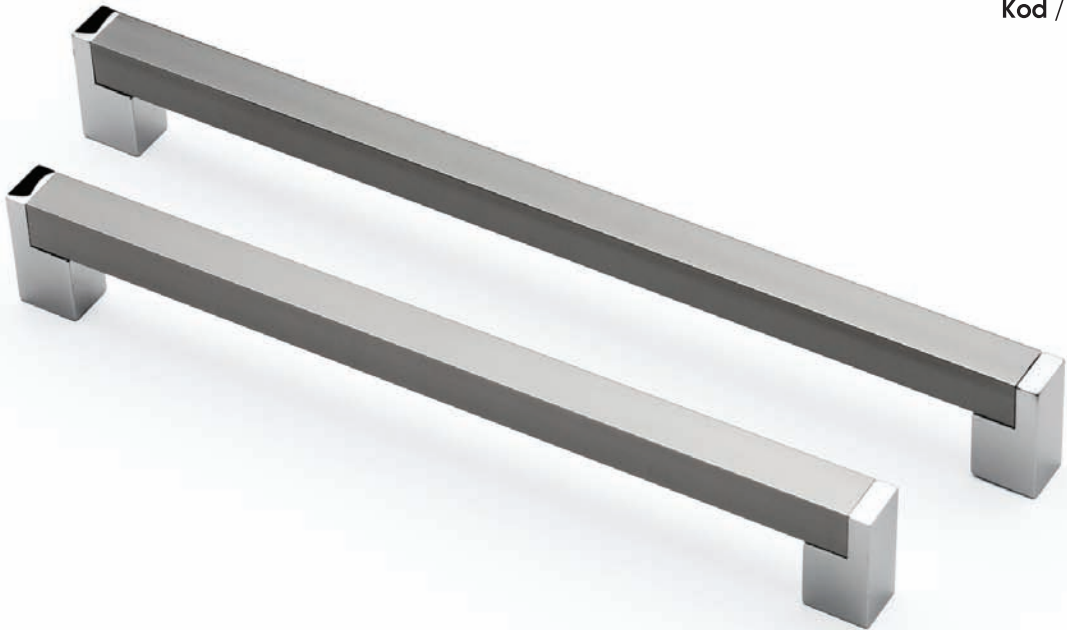

Boy	96 mm	128 mm	160 mm	192 mm	224 mm	256 mm	288 mm	320 mm	352 mm	416 mm
Krom inox	1.89	2.03	2.16	2.30	2.43	2.57	2.70	2.97	3.24	3.60
☒	50	50	50	40	40	40	40	40	40	40

Ø12 Alm.Boy Kulp

Kod / SM-1040



Boy	96 mm	128 mm	160 mm	192 mm	224 mm	256 mm	288 mm	320 mm
inox	3.13	3.38	3.63	3.88	4.25	4.63	5.00	5.50
	50	50	50	50	50	50	50	50

Ø12 Alm.Şeritli Boy Kulp

Kod / SM-1041



Boy	96 mm	128 mm	160 mm	192 mm	224 mm	256 mm	288 mm	320 mm
inox	4.00	4.25	4.50	4.75	5.13	5.50	5.88	6.38
Krom inox	4.00	4.25	4.50	4.75	5.13	5.50	5.88	6.38
	50	50	50	50	50	50	50	50

Ø 10 Demir Boy Kulp

Kod / SM-1042



Boy	96 mm	128 mm	160 mm	192 mm	224 mm	256 mm	288 mm	320 mm
Krom	2.50	2.70	2.90	3.10	3.30	3.50	3.75	4.00
Saten	2.50	2.70	2.90	3.10	3.30	3.50	3.75	4.00
	50	50	50	50	50	50	50	50

Ø 12 Demir Boy Kulp

Kod / SM-1043



Boy	96 mm	128 mm	160 mm	192 mm	224 mm	256 mm	288 mm	320 mm
Krom	2.73	3.00	3.28	3.55	3.83	4.10	4.38	4.68
Saten	2.73	3.00	3.28	3.55	3.83	4.10	4.38	4.68
	50	50	50	50	50	50	50	50

Ebru Kulp

Kod / SM-1044



Boy	160 mm	224 mm
Krom	6.53	7.88
	50	50



Sümer Kulp

Kod / SM-1045



Boy	128 mm	160 mm	192 mm	224 mm	256 mm	288 mm	320 mm
Krom	3.87	4.67	5.45	6.23	7.02	7.80	8.59
	50	50	50	50	50	50	50

Saka Kulp

Kod / SM-1046



Boy	128 mm	160 mm	192 mm	224 mm	256 mm	288 mm	320 mm
Krom	5.25	5.94	6.75	7.65	8.72	9.85	11.07
📦	50	50	50	50	50	50	50



Divan Kulp

Kod / SM-1047



Boy	128 mm	160 mm	192 mm
Krom	3.84	4.52	5.19
📦	50	50	50

Burcu Kulp

Kod / SM-1048

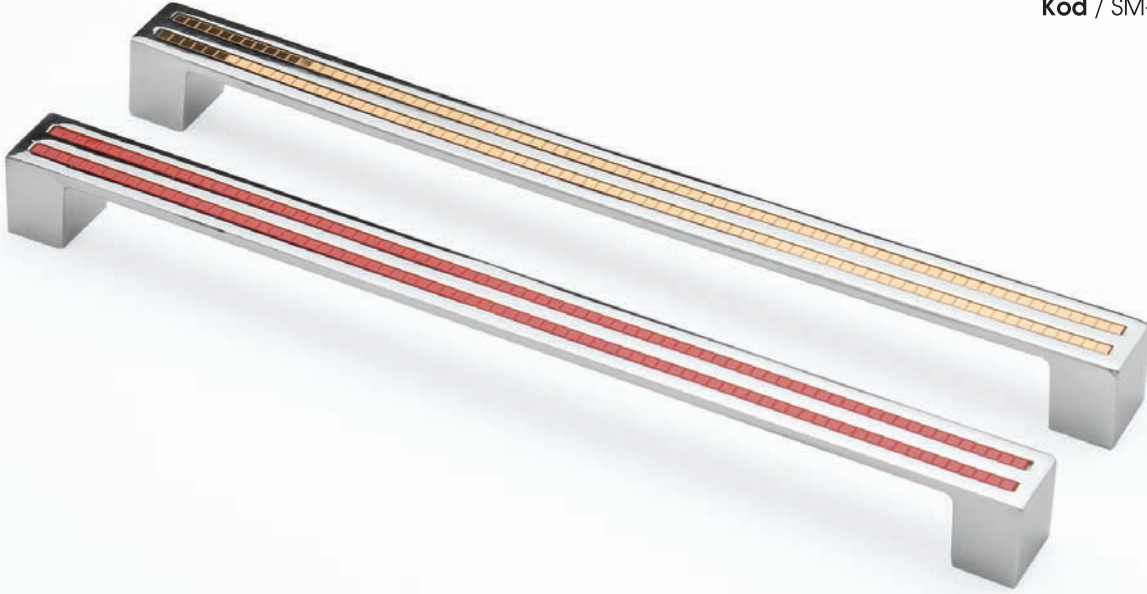

Boy	128 mm	160 mm	224 mm
Krom	4.50	5.40	6.65
	50	40	40



Berrin Kulp

Kod / SM-1049



Boy	128 mm	160 mm	224 mm
Krom	4.50	5.40	6.65
	50	40	40

İnci Kulp
Kod / SM-1050

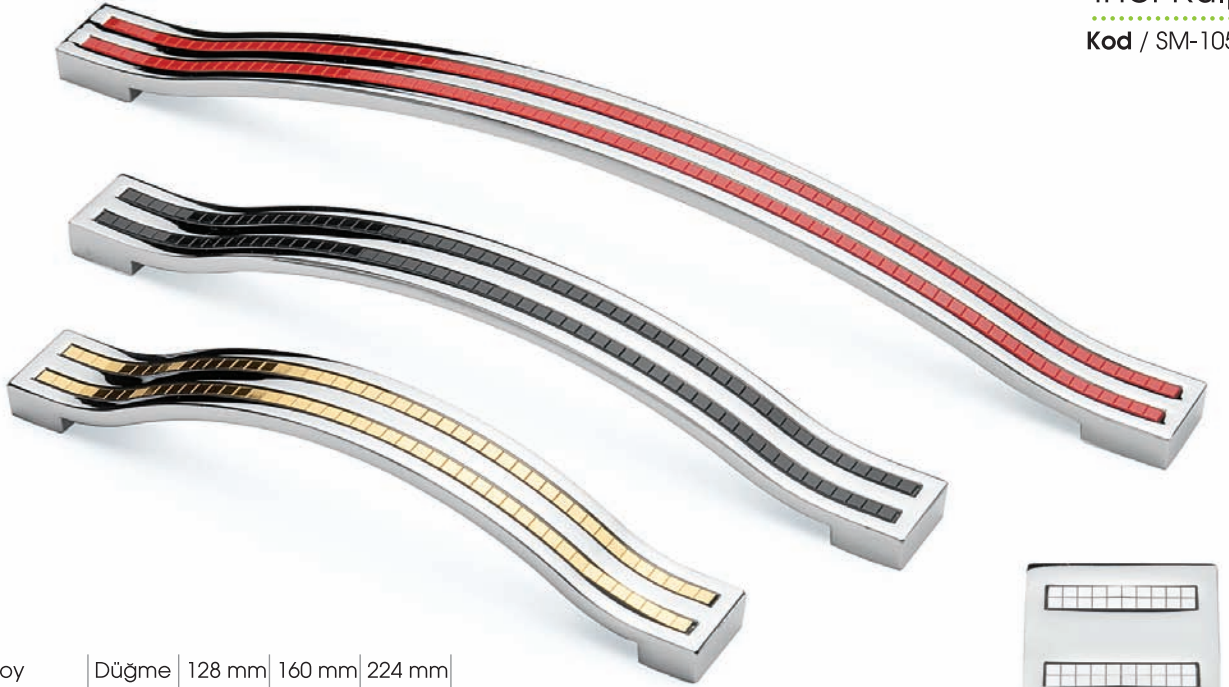

Boy	Düğme	128 mm	160 mm	224 mm
Krom	2.57	3.60	4.50	5.54
☐	50	50	50	50



Roma Kulp
Kod / SM-1051

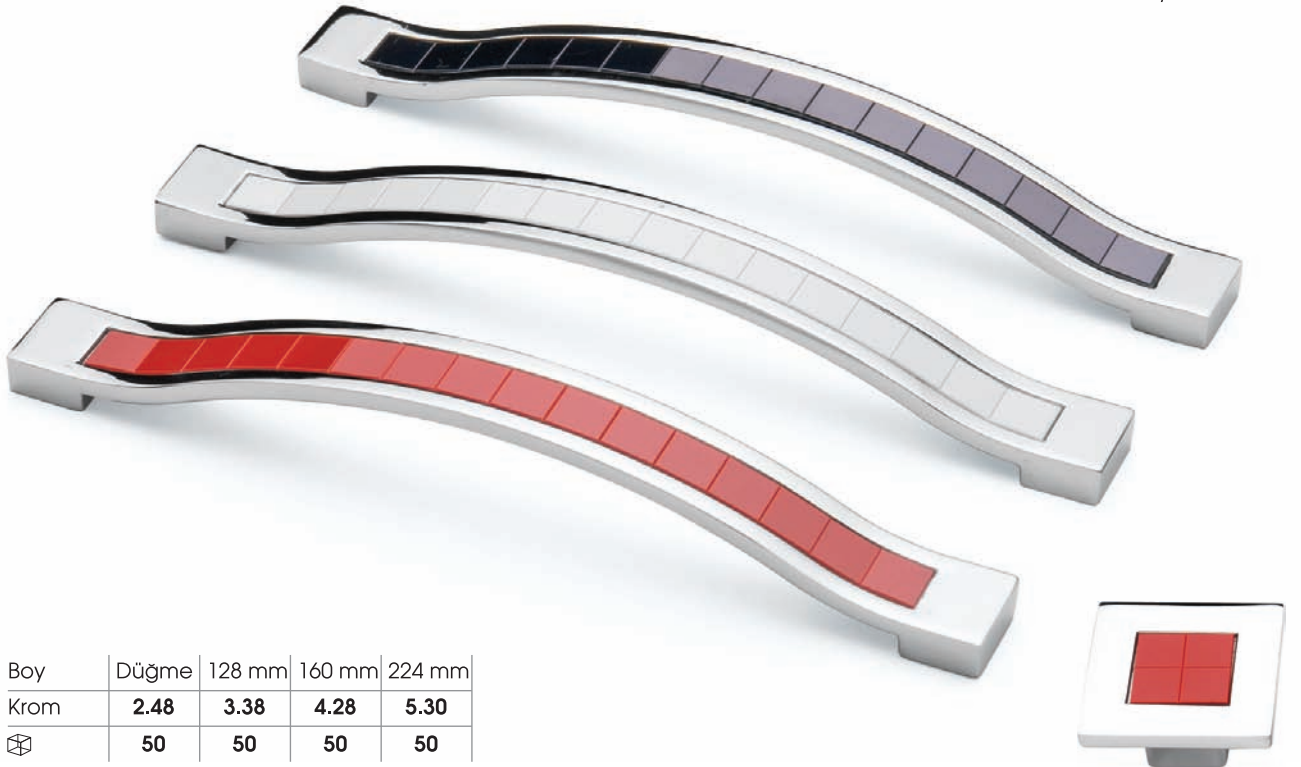

Boy	Düğme	128 mm	160 mm	224 mm
Krom	2.48	3.38	4.28	5.30
☐	50	50	50	50

Meriç Renkli Kulp

Kod / SM-1052



Boy	Düğme	128 mm	160 mm	224 mm
Krom	2.48	3.38	3.94	5.30
	50	50	50	50



Anıl Kulp

Kod / SM-1053

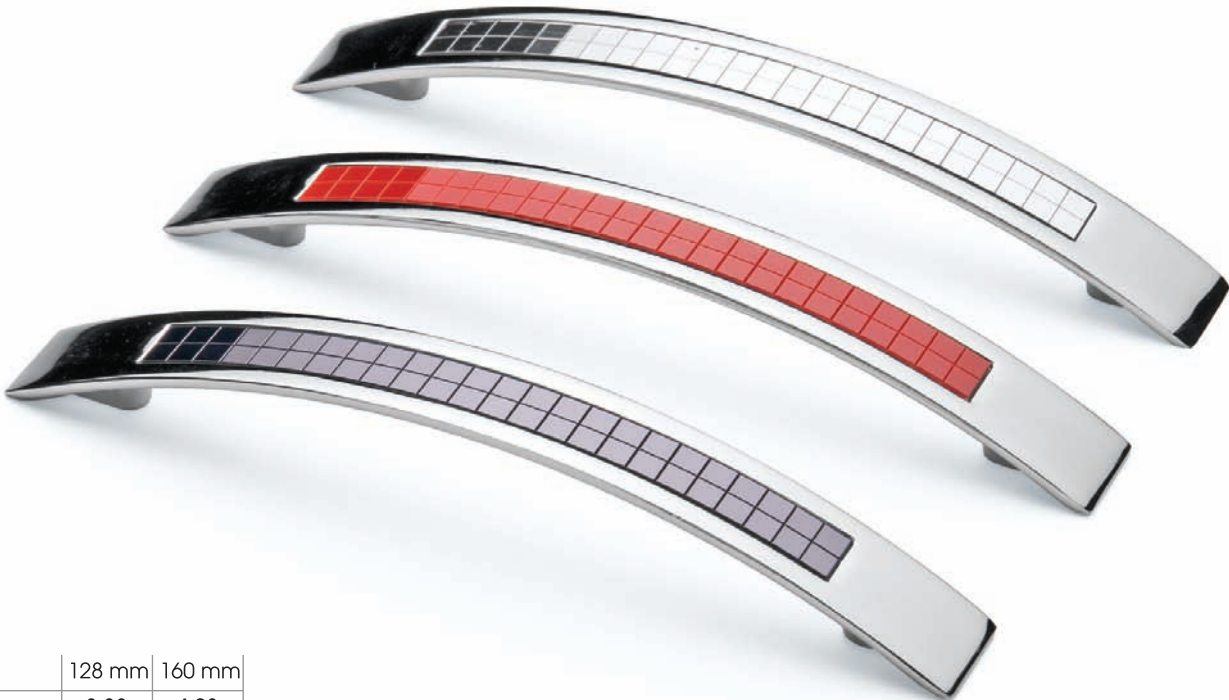

Boy	128 mm	160 mm
Krom	3.38	4.28
	50	50

Beşik Kulp

Kod / SM-1054

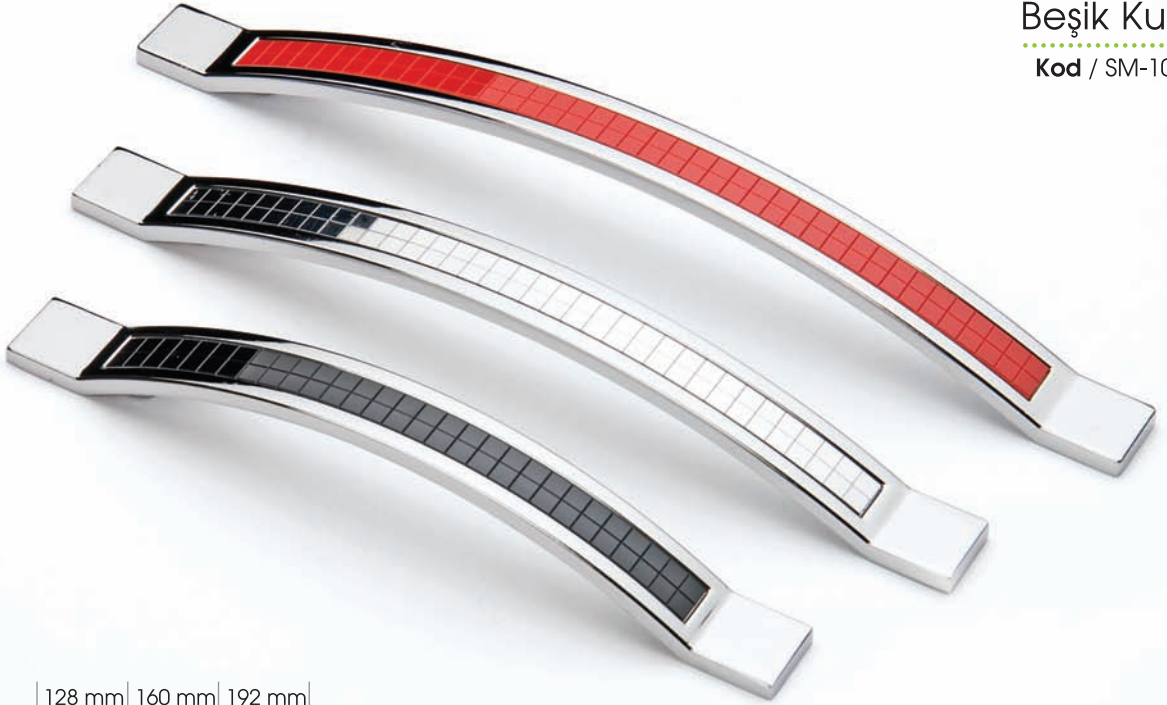

Boy	128 mm	160 mm	192 mm
Krom	3.84	4.52	5.19
☐	50	50	50



Petek Folyolu Kulp

Kod / SM-1055



Boy	128 mm	160 mm	224 mm
Krom	3.60	4.08	5.28
☐	50	50	50

Selvi Kulp

Kod / SM-1056



Boy	96 mm	128 mm	160 mm	128 mm ince
Krom	3.60	5.97	6.75	4.50
Sarı	3.60	5.97	6.75	4.50
	50	40	40	40

Taç Kulp

Kod / SM-1057



Boy	96 mm	128 mm
Krom	3.12	5.64
	50	25

Açelya Kulp
Kod / SM-1058



Boy	160 mm
Krom	6.75
Sarı	6.75
	40

Motif Kulp
Kod / SM-1059



Boy	128 mm
Krom	4.05
Sarı	4.05
	50

Yonca Kulp

Kod / SM-1060

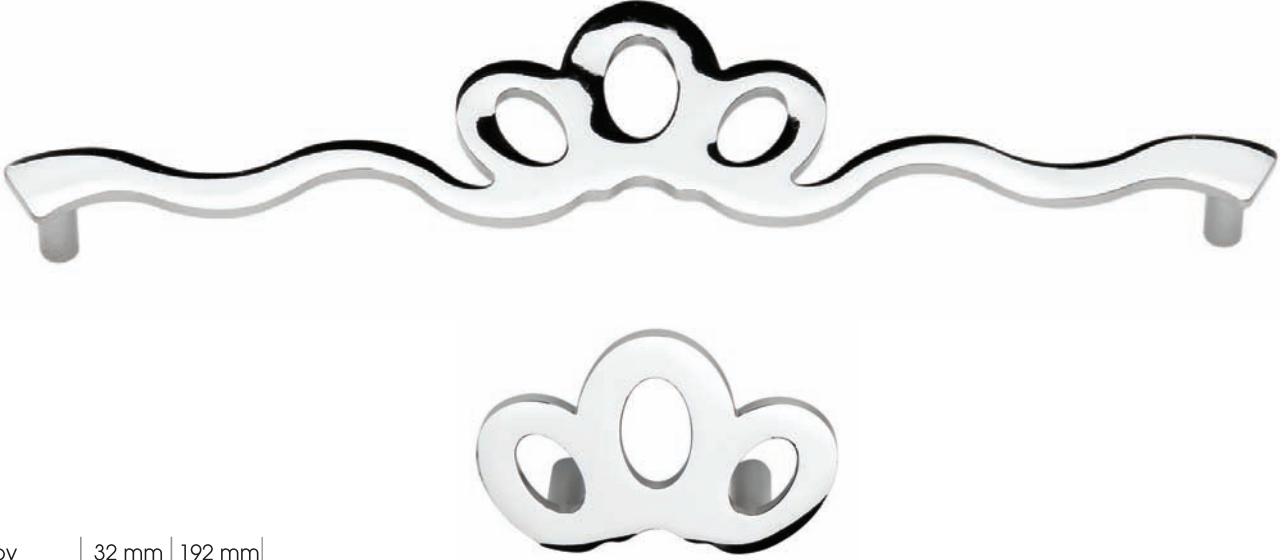

Boy	32 mm	192 mm
Krom	2.03	4.05
Sarı	2.03	4.05
	75	50

Papatya Kulp

Kod / SM-1061



Boy	128 mm
Krom	4.05
Sarı	4.05
	50

Arma Kulp
Kod / SM-1062



Boy	64 mm	128 mm
Krom	4.95	6.53
Sarı	4.95	6.53
📦	40	40

Manolya Kulp
Kod / SM-1063



Boy	32 mm
Krom	3.15
Sarı	3.15
📦	50

Soma Kulp
Kod / SM-1064



Boy	32 mm
Krom	3.38
Inox	3.83
📦	100

Gül Kulp
Kod / SM-1065

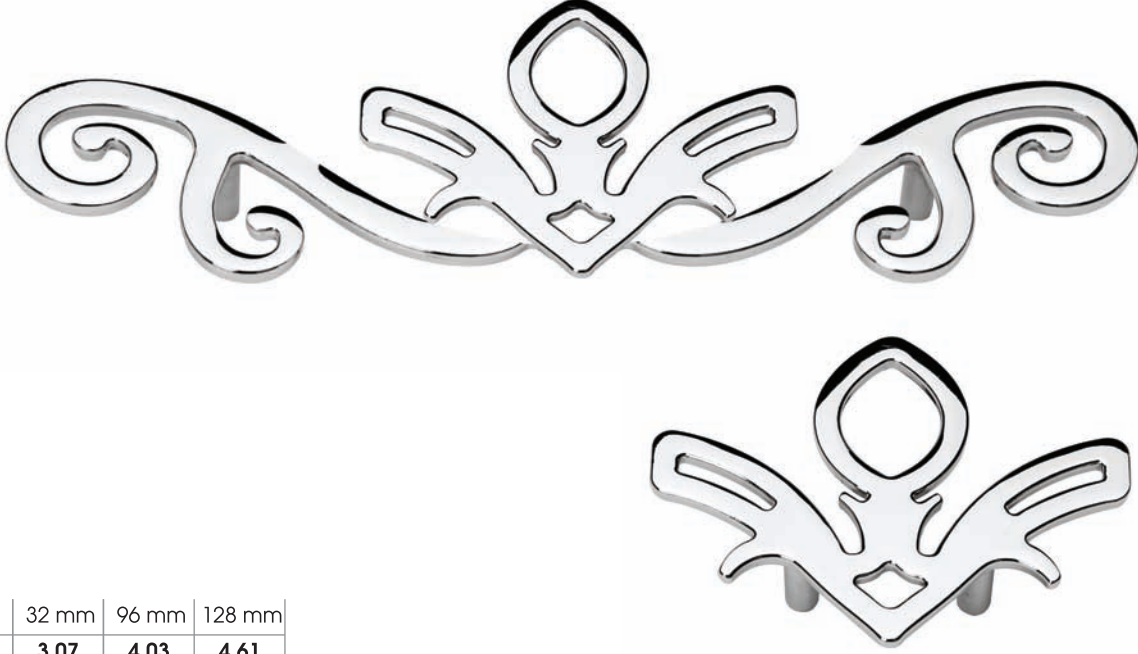

Boy	32 mm	96 mm	128 mm
Krom	3.07	4.03	4.61
	50	30	30

Karanfil Kulp
Kod / SM-1066



Boy	96 mm	128 mm
Krom	5.28	5.76
	30	30

Sarmaşık Kulp
Kod / SM-1067



Boy	32 mm	96 mm	128 mm	160 mm
Krom	5.49	8.82	10.35	12.15
İnox	7.38	10.62	12.15	13.95
Sarı	9.18	11.52	13.05	15.48
	50	40	30	20

Lalegül Kulp
Kod / SM-1068



Boy	128 mm	160 mm
Krom	7.38	9.18
İnox	9.18	10.98
Sarı	10.98	12.78
	30	25

Baklava Kulp

Kod / SM-1069



Boy	64 mm	128 mm	160 mm
Krom	5.94	7.65	9.45
Inox	7.74	9.45	11.25
Sarı	9.54	11.25	13.05
	50	50	30

Fantazi Kulp

Kod / SM-1070



Boy	32 mm	160 mm
Krom	6.66	9.99
Inox	8.46	11.79
Sarı	10.26	13.59
	50	30

Kare Kulp
Kod / SM-1071



Boy	64 mm	160 mm
Krom	5.76	9.00
Inox	7.56	10.35
Sarı	9.36	12.15
📦	50	30

Kareli Kulp
Kod / SM-1072



Boy	64 mm	160 mm
Krom	5.85	9.18
Inox	7.65	10.53
Sarı	9.45	12.33
📦	50	30

Halkalı Kulp

Kod / SM-1073



Boy	32 mm	128 mm
Krom	5.22	8.82
İnox	7.02	10.62
Sarı	8.82	11.52
	50	40

Taşlı Kulp

Kod / SM-1074



Boy	32 mm	128 mm
Krom	8.28	13.05
İnox	9.18	14.85
Sarı	10.17	15.75
	50	40

Elips Kulp
Kod / SM-1075



Boy	32 mm	72 mm
Krom	3.38	5.18
inox	3.83	5.76
📦	100	50

64 Halka Kulp
Kod / SM-1076



Boy	64 mm
Krom	3.87
inox	4.54
📦	50

32 Halka Kulp
Kod / SM-1077



Boy	32 mm
Krom	4.50
Sarı	4.50
📦	50

Tekli Halka Kulp
Kod / SM-1078



Boy	Düğme	16 mm ince
Krom	3.38	1.89
Sarı	3.38	1.89
📦	150	100

Kare Taşlı Kulp

Kod / SM-1079



Boy	Düğme
Krom	7.88
Inox	8.33
Sarı	8.33
	50

K 16 T Kulp

Kod / SM-1080



Boy	24 mm
Krom	15.30
Inox	16.20
Siyah	14.40
	25

32 Kare Kulp

Kod / SM-1081



Boy	32 mm
Krom	4.05
	50

Broş Kulp

Kod / SM-1082



Boy	32 mm
Krom	3.60
	50

Oval Taşlı Kulp

Kod / SM-1083



Boy	128 mm
Krom	6.21
Inox	6.62
Sarı	5.85
	50

Pırlanta Kulp

Kod / SM-1084



Boy	96 mm	128 mm	160 mm	192 mm	224 mm
Krom	3.36	3.65	4.23	4.99	5.38
M.Siyah	3.36	3.65	4.23	4.99	5.38
	50	50	50	50	50

Gelincik Kulp

Kod / SM-1085



Boy	96 mm	128 mm	160 mm	192 mm	224 mm
Krom	3.36	3.65	4.23	4.99	5.38
M.Siyah	3.36	3.65	4.23	4.99	5.38
	50	50	50	50	50

Zümrüt Kulp

Kod / SM-1086



Boy	96 mm	128 mm	160 mm	192 mm	224 mm
Krom	3.36	3.65	4.23	4.99	5.38
M.Siyah	3.36	3.65	4.23	4.99	5.38
	50	50	50	50	50

Kristal Kulp
Kod / SM-1087



Boy	96 mm	128 mm	160 mm
Saten	1.92	2.69	3.36
Krom	1.92	2.69	3.36
M.Krom	2.02	2.79	3.46
	50	50	50

Sedir Kulp
Kod / SM-1088



Boy	96 mm	128 mm	160 mm
Saten	1.92	2.69	3.36
Krom	1.92	2.69	3.36
M.Krom	2.02	2.79	3.46
	100	50	50

Menekşe Kulp

Kod / SM-1089



Boy	96 mm	128 mm	160 mm
Saten	4.04	4.61	5.19
Krom	4.04	4.61	5.19
M.Krom	4.04	4.61	5.19
☐	30	30	30

Sümbül Kulp

Kod / SM-1090



Boy	96 mm	128 mm	160 mm
Saten	1.92	2.69	3.36
Krom	1.92	2.69	3.36
M.Krom	1.92	2.69	3.36
☐	100	50	50

Sima Kulp
Kod / SM-1091

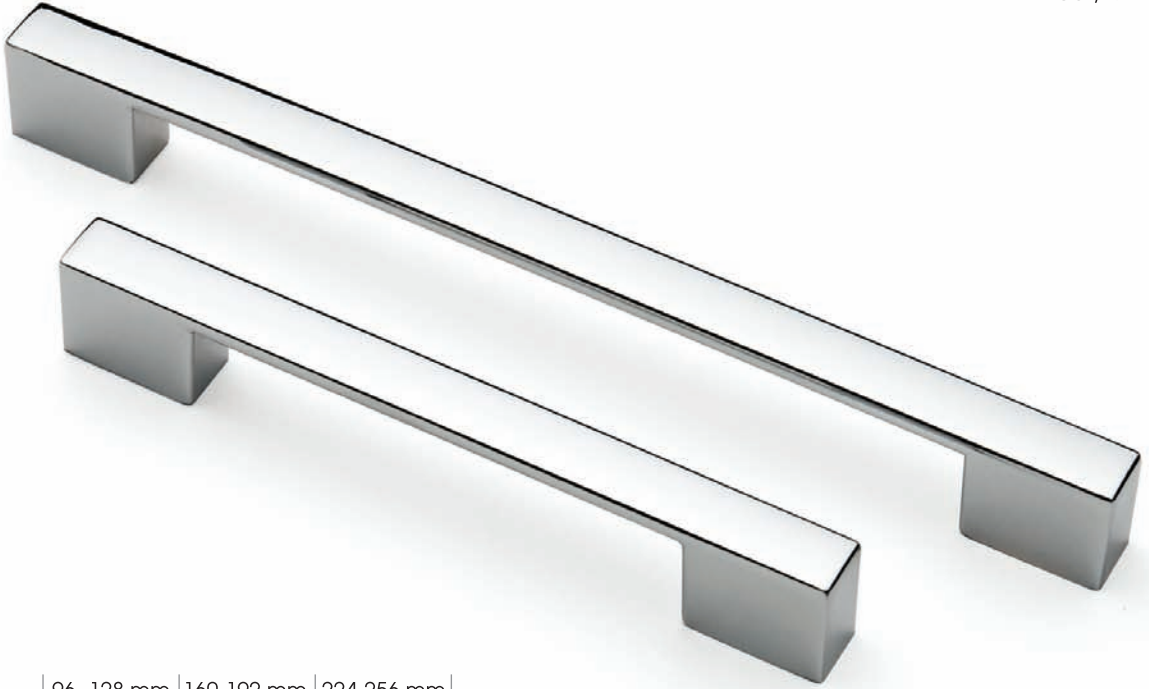

Boy	96 -128 mm	160-192 mm	224-256 mm
Krom	3.91	4.60	5.75
	50	50	50

Doğan Kulp
Kod / SM-1092

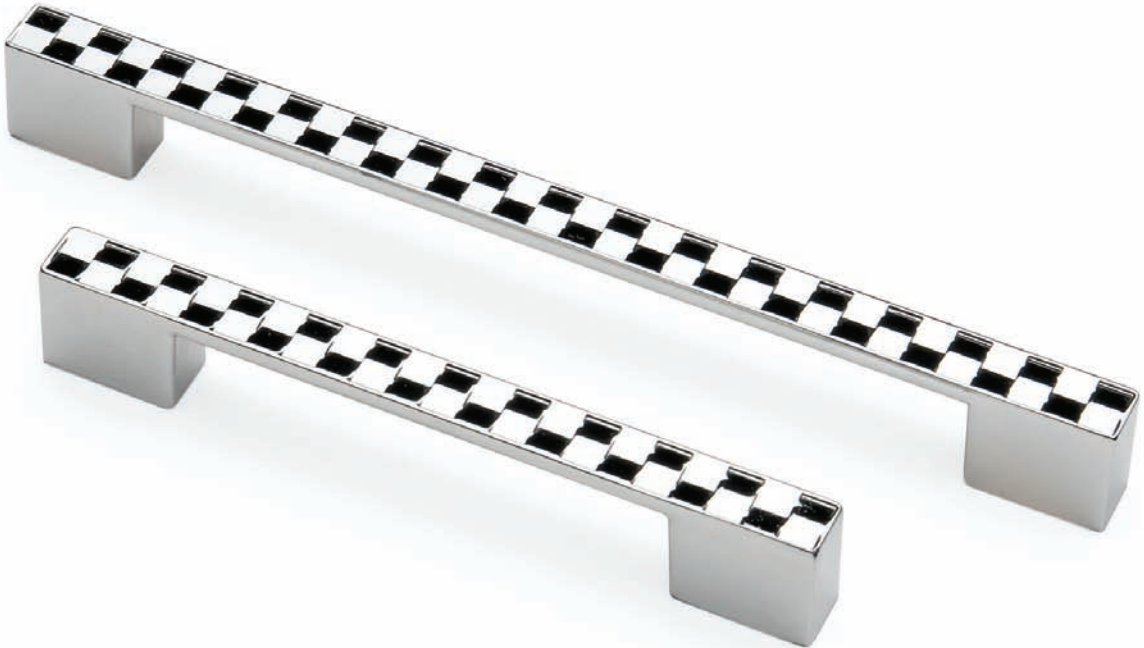

Boy	96 -128 mm	160-192 mm	224-256 mm
Krom	3.91	4.60	5.75
	50	50	50

Acar Kulp

Kod / SM-1093



Boy	128 mm	160 mm	224 mm
Krom	4.50	5.40	6.66
İnox	5.04	5.94	7.20
Şeritli	5.04	5.94	7.20
	50	40	40

Yalı Kulp

Kod / SM-1094



Boy	128 mm	160 mm	224 mm
Krom	2.64	3.12	5.28
İnox	2.88	3.36	5.52
K.İnox	2.88	3.36	5.52
Şeritli	3.12	3.60	5.76
	50	50	50

Meriç Kulp
Kod / SM-1095



Boy	128 mm	160 mm	192 mm
Krom	3.87	4.32	4.68
K.inox	4.14	4.50	4.95
Şeritli	4.22	4.73	5.02
	50	50	50

Tuna Kulp
Kod / SM-1096



Boy	96 mm	160 mm
Krom	3.06	3.87
K.inox	3.24	4.14
Şeritli	3.87	4.77
	50	50

Aris Kulp

Kod / SM-1097



Boy	96 mm	128 mm	160 mm	192 mm
Krom	2.52	3.06	3.15	4.50
K.Inox	2.61	3.15	3.33	4.68
	50	50	50	50

Yonca Şeritli Kulp

Kod / SM-1098



Boy	96 mm	128 mm	160 mm
Şeritli	3.00	3.48	4.08
	100	50	50

Venedik Kulp
Kod / SM-1099



Boy	96 mm	128 mm	160 mm	192 mm
Krom	2.34	2.57	3.22	3.78
K.inox	2.52	2.79	3.38	3.96
	75	50	50	50

Site Kulp
Kod / SM-1100



Boy	96 mm	128 mm	160 mm	192 mm
Krom	2.70	3.24	3.51	4.32
K.inox	2.88	3.42	3.69	4.50
	75	50	50	50

Kılıç Kulp

Kod / SM-1101



Boy	96-128 mm	160 mm	192-224 mm
Krom	3.12	3.60	3.84
K.inox	3.48	3.96	4.20
Inox	3.48	3.96	4.20
	75	50	50

Özel Kulp

Kod / SM-1102



Boy	128 mm	160 mm	192 mm
Krom	2.16	2.34	3.15
K.inox	2.25	2.48	3.32
	75	75	50

Sedef Kulp
Kod / SM-1103



Boy	96 -128 mm	160 mm	224 mm
Krom	3.12	3.60	4.80
Inox	3.48	3.96	5.28
Kr.Inox	3.48	3.96	5.28
📦	50	50	50

Petek Kulp
Kod / SM-1104



Boy	128 mm	160 mm	224 mm
Krom	3.60	4.08	5.28
📦	50	50	50



Delta Kulp

Kod / SM-1105

Boy	96 mm	128 mm
Krom	1.71	2.07
K.inox	1.79	2.16
Nikel inox	1.52	1.80
	100	75



Akasya Kulp

Kod / SM-1106

Boy	128 mm
Krom	2.70
K.inox	2.88
	50



Hazar Kulp

Kod / SM-1107

Boy	96 mm	128 mm
Krom	2.38	3.06
K.inox	2.51	3.21
	75	75



Plato Kulp

Kod / SM-1108

Boy	96 mm	128 mm
Krom	2.48	2.88
K.inox	2.60	3.02
	75	75



Nil Kulp
Kod / SM-1109

Boy	96 mm	128 mm	192 mm	224 mm
Krom	1.43	2.34	2.64	4.56
K.inox	1.52	2.43	3.36	5.40
	100	50	50	25



Eko Nil Kulp
Kod / SM-1110

Boy	128 mm
K.inox	1.98
Nikel inox	1.55
	75



Cemre Kulp
Kod / SM-1111

Boy	96 mm	128 mm	160 mm	224 mm
Krom	1.62	2.13	2.70	3.42
K.inox	1.67	2.25	2.81	3.60
	100	100	75	50



Eko Cemre Kulp
Kod / SM-1112

Boy	96 mm	128 mm
K.inox	1.01	1.26
	100	100



Berilay Kulp

Kod / SM-1113

Boy	96 mm	128 mm
Krom	1.80	2.04
inox	1.92	2.16
K.inox	1.92	2.16
📦	75	75



Kumru Kulp

Kod / SM-1114

Boy	96 mm	128 mm
Krom	0.66	0.96
K.inox	0.66	0.96
📦	200	150



Eko Sülün Kulp

Kod / SM-1115

Boy	96 mm
Krom	0.66
K.inox	0.66
📦	150



As Sülün Kulp

Kod / SM-1116

Boy	96 mm
Krom	0.89
inox	1.00
K.inox	1.00
📦	100

Papyon Kulp

Kod / SM-1117



Boy	96 mm	128 mm
Krom	1.56	1.80
inox	1.68	1.92
K.inox	1.68	1.92
Saten	0.96	1.20
📦	100	75

Eko Papyon Kulp

Kod / SM-1118



Boy	96 mm	128 mm
Krom	0.71	1.68
K.inox	0.71	1.68
📦	150	75

Ördek Ayağı Kulp

Kod / SM-1119



Boy	96 mm
Saten	0.77
Krom	0.89
K.inox	1.01
📦	150

İnci Kulp
Kod / SM-1120

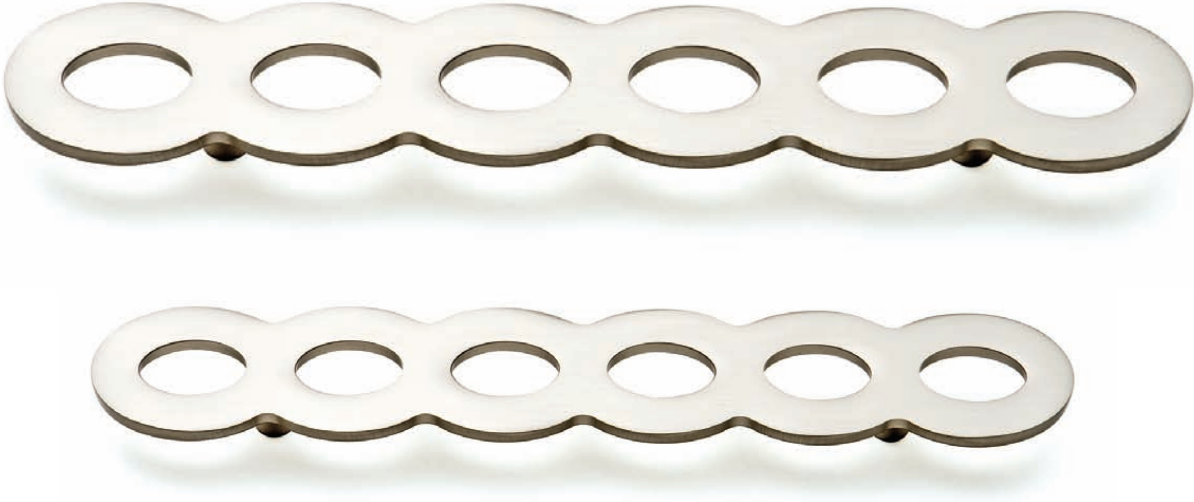

Boy	64 mm	128 mm
Krom	5.58	9.09
inox	7.38	10.35
Sarı	9.18	12.15
	50	30

Dalgalı Kulp
Kod / SM-1121



Boy	128 mm	192 mm
Krom	7.92	8.64
inox	9.72	10.44
Sarı	11.52	12.24
	40	30

Boğaziçi Kulp

Kod / SM-1122



Boy	128 mm	192 mm
Krom	6.48	7.47
Kr.inox	7.38	8.37
inox	8.28	9.99
	40	30

Yarasa Kulp

Kod / SM-1123



Boy	128 mm	192 mm
Krom	6.93	7.74
Kr.inox	7.83	8.64
inox	8.82	10.44
	40	30

Mekik Kulp

Kod / SM-1124



Boy	128 mm	160 mm	224 mm
Krom	5.85	6.48	7.92
Kr.inox	6.75	7.38	8.82
inox	7.65	8.46	10.17
	50	40	30

Kobra Kulp

Kod / SM-1125



Boy	128 mm	160 mm	224 mm
Krom	6.21	7.11	8.01
Kr.inox	7.11	8.01	8.91
inox	8.01	9.18	10.62
	50	30	30

Bedir Kulp

Kod / SM-1126



Boy	128 mm	160 mm	224 mm
Krom	5.94	6.93	8.46
Kr.inox	6.84	7.83	9.36
inox	7.74	8.73	10.62
📦	50	40	30

Ahize Kulp

Kod / SM-1127



Boy	128 mm	160 mm	224 mm
Krom	5.85	7.29	8.28
Kr.inox	6.75	8.19	9.18
inox	7.65	9.45	10.62
📦	50	30	25

Kamer Kulp

Kod / SM-1128



Boy	128 mm	160 mm	224 mm
Krom	5.58	5.76	8.01
Kr.inox	6.48	6.66	8.91
inox	7.38	7.65	9.81
	40	30	30

Tuna Kulp

Kod / SM-1129



Boy	128 mm	160 mm	224 mm
Krom	5.67	6.57	7.65
Kr.inox	6.57	7.47	8.55
inox	7.47	8.37	9.81
	50	50	30

Mostar Kulp
Kod / SM-1130



Boy	128 mm	160 mm	224 mm	320 mm
Krom	6.75	8.01	8.91	14.76
Kr.inox	7.65	8.91	9.81	16.56
inox	8.91	10.10	11.61	18.36
📦	40	30	20	20

Köprü Kulp
Kod / SM-1131



Boy	128 mm	160 mm	224 mm
Krom	5.76	6.75	8.01
Kr.inox	6.66	7.65	8.91
inox	7.56	8.55	9.81
📦	50	40	30

Aras Kulp

Kod / SM-1132



Boy	128 mm	160 mm	224 mm
Krom	6.21	7.11	7.74
inox	8.01	8.91	9.72
	50	40	30

Toros Kulp

Kod / SM-1133



Boy	128 mm	160 mm	224 mm
Krom	6.12	6.93	7.83
Kr.inox	7.11	7.83	8.73
inox	7.92	8.91	9.81
	50	40	30

Yalı Kulp
Kod / SM-1134



Boy	160 mm	192 mm
Saten	3.65	4.04
Krom	3.65	4.04
M.Krom	3.75	4.14
Kr.inox	4.13	4.42
	50	50

Sülün Kulp
Kod / SM-1135



Boy	128 mm	160 mm	192 mm
Saten	2.88	3.36	3.65
Krom	2.88	3.36	3.65
M.Krom	2.98	3.46	3.75
Kr.inox	3.27	3.65	4.04
	50	50	50

Sude Kulp
Kod / SM-1136



Boy	128 mm	160 mm	192 mm
Saten	3.65	4.04	4.32
Krom	3.65	4.04	4.32
M.Krom	3.75	4.14	4.42
K.inox	4.13	4.42	4.71
	50	50	50



Damla Kulp

Kod / SM-1137

Boy	128 mm	160 mm	192 mm
Saten	3.65	4.04	4.32
Krom	3.65	4.04	4.32
M.Krom	3.75	4.14	4.42
📦	50	50	50



Sepet Kulp

Kod / SM-1138

Boy	128 mm	160 mm	192 mm
Saten	3.36	3.65	4.04
Krom	3.36	3.65	4.04
M.Krom	3.36	3.65	4.04
📦	50	50	50



Melita Kulp

Kod / SM-1139

Boy	160 mm	192 mm	224 mm
Krom	3.12	3.72	4.28
📦	50	50	50

Hisar Kulp

Kod / SM-1140



Boy	96 mm	128 mm	160 mm	224 mm
Saten	1.54	2.31	3.27	4.61
Krom	1.54	2.31	3.27	4.61
M.Krom	1.64	2.41	3.37	4.71
Kr.inox	1.92	2.69	3.65	4.99
☐	100	50	50	50

Yeni Lama Kulp

Kod / SM-1141



Boy	128 mm	160 mm	192 mm
Saten	3.65	4.04	4.32
Krom	3.65	4.04	4.32
M.Krom	3.75	4.14	4.42
Kr.inox	4.04	4.32	4.61
☐	50	50	50

Armoni Kulp

Kod / SM-1142



Boy	160 mm	192 mm	224 mm
Krom	4.20	4.80	5.40
inox	4.44	5.04	5.64
Şeritli	4.76	5.36	5.96
☐	50	50	50



Tuna Kumlu

Kod / SM-1143

Boy	96 mm	160 mm
Saten	2.16	2.40
Krom	3.00	3.60
M.Krom	2.16	2.40
Kr.inox	3.36	3.96
inox	3.36	3.96
	75	50



Yalı Kare Kulp

Kod / SM-1144

Boy	128 mm	160 mm
Saten	1.92	2.16
M.Krom	1.92	2.16
Krom	2.64	3.12
Kr.inox	2.88	3.36
inox	2.88	3.36
	50	50



Saray Kulp

Kod / SM-1145

Boy	128 mm	192 mm
Saten	2.69	3.65
M.Krom	2.79	3.75
Krom	2.69	3.65
Kr.inox	2.88	4.04
	50	50



Vezir Kulp

Kod / SM-1146

Boy	128 mm	160 mm
Saten	3.17	3.55
Krom	3.17	3.55
M.Krom	3.27	3.65
Kr.inox	3.46	4.04
📦	50	50



Nehir Kulp

Kod / SM-1147

Boy	128 mm
Saten	1.92
Krom	1.92
M.Krom	2.02
Kr.inox	2.31
📦	50



Çavuş Kulp

Kod / SM-1148

Boy	96 mm	128 mm
Saten	1.00	1.40
Krom	1.00	1.40
M.Krom	1.06	1.44
Kr.inox	1.54	1.92
📦	100	50



Ulus Kulp

Kod / SM-1149

Boy	96 mm	128 mm
Saten	1.11	1.54
Krom	1.11	1.54
M.Krom	1.16	1.64
Kr.inox	1.44	1.92
📦	100	50



Stil Kulp

Kod / SM-1150

Boy	96 mm	128 mm
Saten	1.11	1.92
Krom	1.11	1.92
M.Krom	1.16	2.02
Kr.inox	1.54	2.40
	100	50



Selvi Kulp

Kod / SM-1151

Boy	96 mm	128 mm
Saten	1.11	1.92
Krom	1.11	1.92
M.Krom	1.16	2.02
Kr.inox	1.54	2.40
	100	50



Yeni Papyon Kulp

Kod / SM-1152

Boy	96 mm	128 mm
Saten	1.54	1.92
Krom	1.54	1.92
M.Krom	1.59	2.02
Kr.inox	2.02	2.40
	50	50



Klas Kulp

Kod / SM-1153

Boy	96 mm	128 mm
Saten	0.96	1.35
Krom	0.96	1.35
M.Krom	1.01	1.40
Kr.inox	1.40	1.73
	50	50



Star Noktalı Kulp

Kod / SM-1154

Boy	96 mm
Saten	1.11
Krom	1.11
M.Krom	1.16
☒	200

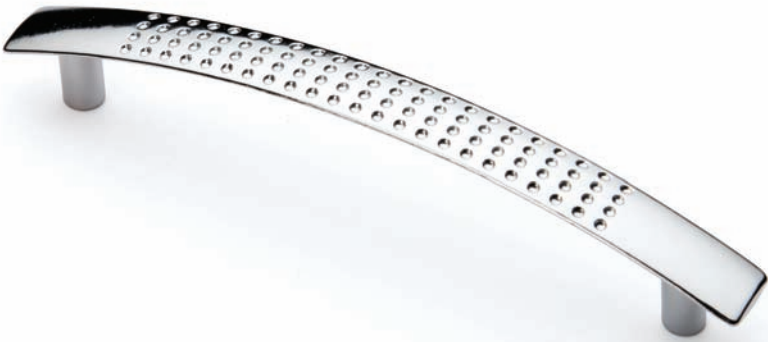

Eko Ayaklı Noktalı Kulp

Kod / SM-1155

Boy	96 mm
Saten	0.74
Krom	0.74
M.Krom	0.77
☒	100



Eko Yeni Noktalı Kulp

Kod / SM-1156

Boy	96 mm
Saten	0.96
Krom	0.96
M.Krom	1.01
☒	100



Klas Noktalı Kulp

Kod / SM-1157

Boy	96 mm
Saten	0.74
Krom	0.74
M.Krom	0.77
☒	100



Eko Noktalı Kulp

Kod / SM-1158

Boy	96 mm
Saten	0.96
Krom	0.96
M.Krom	1.01
	100



Eko Baklavalı Kulp

Kod / SM-1159

Boy	96 mm
Saten	0.96
Krom	0.96
M.Krom	1.01
	100



Eko Çift Baklavalı Kulp

Kod / SM-1160

Boy	96 mm
Saten	0.96
Krom	0.96
M.Krom	1.01
	100



Eko Düz Kulp

Kod / SM-1161

Boy	96 mm
Saten	0.96
Krom	0.96
M.Krom	1.01
	100

Eko Çiçekli Kulp

Kod / SM-1162



Boy	96 mm	
Saten	0.74	
Krom	0.74	
M.Krom	0.77	
📦	100	

Çizgili Kulp

Kod / SM-1163



Boy	96 mm	128 mm
Saten	1.54	1.92
Krom	1.54	1.92
M.Krom	1.59	2.02
📦	100	50

Deve Tabanı Kulp

Kod / SM-1164



Boy	64 mm	96 mm
Saten	0.74	1.00
Krom	0.74	1.00
M.Krom	0.77	1.06
📦	200	100

Yunus Kulp

Kod / SM-1165



Boy	64 mm	96 mm
Saten	0.74	1.06
Krom	0.74	1.06
M.Krom	0.77	1.11
📦	200	100



Alm.T Boy Kulp

Kod / SM-1166

Boy	Kr.M.Krom	☐
96 mm	1.15	100
128 mm	1.25	75
160 mm	1.35	75
192 mm	1.45	50
224 mm	1.55	50
256 mm	1.65	50
288 mm	1.75	50
320 mm	1.85	50



Alm. Eko Tirtir Kulp

Kod / SM-1167

Boy	Kr.M.Krom	☐
96 mm	2.16	100
128 mm	2.28	75
160 mm	2.40	50
192 mm	2.52	50
224 mm	2.64	50
256 mm	2.88	50
288 mm	3.12	50
320 mm	3.36	50



Alm. Noktalı Kulp

Kod / SM-1168

Boy	Kr.M.Krom	☐
96 mm	1.59	100
128 mm	1.70	100
160 mm	1.82	100
192 mm	1.93	100
224 mm	2.05	100
256 mm	2.16	50
288 mm	2.28	50
320 mm	2.39	50

Alm. Çizgili Kulp

Kod / SM-1169



Boy	Kr.M.Krom	☒
96 mm	1.59	100
128 mm	1.70	100
160 mm	1.82	100
192 mm	1.93	100
224 mm	2.05	100
256 mm	2.16	50
288 mm	2.28	50
320 mm	2.39	50

Alm. Şahin Kulp

Kod / SM-1170



Boy	Kr.M.Krom	☒
96 mm	1.59	100
128 mm	1.70	100
160 mm	1.82	100
192 mm	1.93	100
224 mm	2.05	100
256 mm	2.16	50
288 mm	2.28	50
320 mm	2.39	50

Alm. Kumru Kulp

Kod / SM-1171



Boy	Kr.M.Krom	☒
96 mm	1.59	100
128 mm	1.70	100
160 mm	1.82	100
192 mm	1.93	100
224 mm	2.05	100
256 mm	2.16	50
288 mm	2.28	50
320 mm	2.39	50



Alm. Serçe Kulp

Kod / SM-1172

Boy	Kr.M.Krom	☐
96 mm	1.73	100
128 mm	1.88	100
160 mm	2.02	100
192 mm	2.16	100
224 mm	2.31	100
256 mm	2.45	50
288 mm	2.60	50
320 mm	2.74	50



Alm. Kartal Kulp

Kod / SM-1173

Boy	Kr.M.Krom	☐
96 mm	1.73	100
128 mm	1.88	100
160 mm	2.02	100
192 mm	2.16	100
224 mm	2.31	100
256 mm	2.45	50
288 mm	2.60	50
320 mm	2.74	50



Alm. Atmaca Kulp

Kod / SM-1174

Boy	Kr.M.Krom	☐
96 mm	1.73	100
128 mm	1.88	100
160 mm	2.02	100
192 mm	2.16	100
224 mm	2.31	100
256 mm	2.45	50
288 mm	2.60	50
320 mm	2.74	50



Filiz Kulp
Kod / SM-1175

Boy	Saten	Krom	M.Krom	☐
96	1.35	1.35	1.40	100



Kare Folyolu Kulp
Kod / SM-1176

Boy	Saten	Krom	M.Krom	☐
96	1.35	1.35	1.40	100



Badem Kulp
Kod / SM-1177

Boy	Saten	Krom	M.Krom	☐
96	1.35	1.35	1.40	100



Sultan Kulp
Kod / SM-1178

Boy	Saten	Krom	M.Krom	☐
96	1.35	1.35	1.40	100

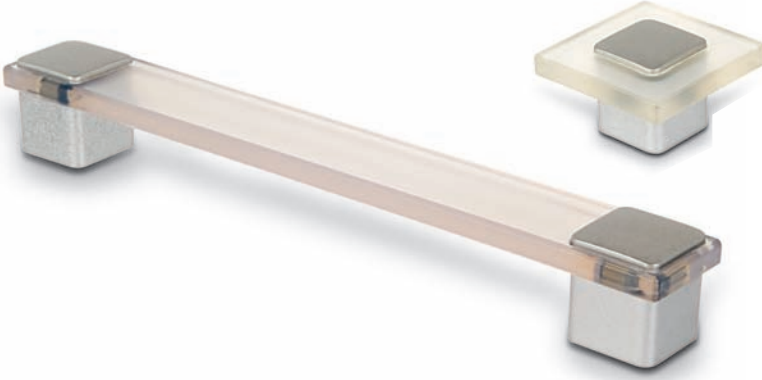

Pls. Köşeli Kulp

Kod / SM-1179

Boy	Düğme	128 mm	160 mm
M.Kr.,Şeffaf	1.13	1.75	1.83
☒	50	50	50

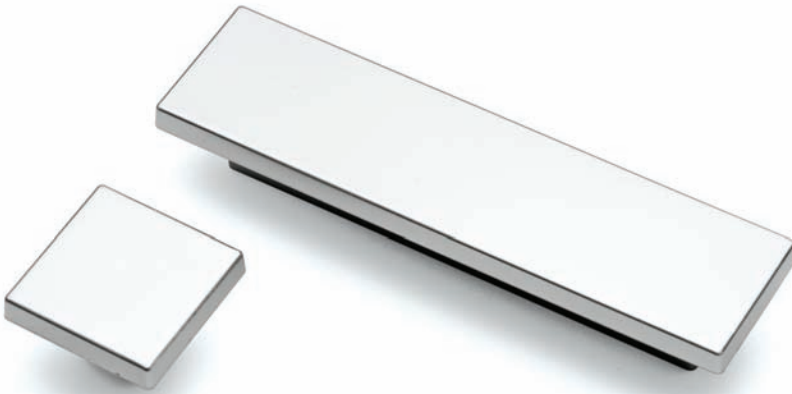

Pls.Kare Kulp

Kod / SM-1180

Boy	Düğme	64 mm
M.Krom	0.78	1.50
☒	50	50



Pls.Yunus Kulp

Kod / SM-1181

Boy	96 mm
M.Krom	0.92
☒	100



Pls.Boy Kulp

Kod / SM-1182

Boy	96 mm
M.Krom	0.92
☒	100

Yeni Gömme Kulp

Kod / SM-1183



Boy	Kr.M.Krom	📦
64 mm	1.86	50
96 mm	2.27	50
128 mm	2.70	50
160 mm	3.03	40
192 mm	3.41	30
224 mm	3.78	30
256 mm	4.14	30
288 mm	4.53	30
320 mm	4.92	30

Sebat Gömme Kulp

Kod / SM-1184



Boy	Kr.M.Krom	📦
64 mm	1.71	75
96 mm	1.98	50
128 mm	2.21	50
160 mm	2.43	50
192 mm	2.61	50
224 mm	3.06	50
256 mm	3.15	50
288 mm	3.33	50
320 mm	3.60	50

Tabaka Kulp

Kod / SM-1185



Boy	Kr.M.Krom	📦
Düğme	1.25	200
32 mm	1.73	100
64 mm	2.21	75
96 mm	2.60	50

Yeni Volga Kulp

Kod / SM-1186



Boy	32 mm	64 mm
Kr.M.Krom	2.52	3.60
Kr.Siyah	2.64	3.84
📦	100	75

Midye Kulp

Kod / SM-1187



Boy	32 mm	96 mm
Saten	1.16	2.12
Krom	1.16	2.12
M.Krom	1.21	2.21
📦	100	75

Gömme Kulp

Kod / SM-1188



Boy	32 mm	96 mm
Saten	1.11	1.68
Krom	1.11	1.68
M.Krom	1.16	1.73
📦	100	50

Kenar Gömme Kulp

Kod / SM-1189



Boy	128 mm
Saten	2.40
M.Krom	2.40
📦	50

Meriç Düğme

Kod / SM-1190



Saten	Krom	M.Kr.	📦
0.96	0.96	1.01	200

Mercan Düğme

Kod / SM-1191



Saten	Krom	M.Kr.	📦
0.77	0.77	0.79	200

Menekşe Düğme

Kod / SM-1192



Saten	Krom	M.Kr.	📦
0.77	0.77	0.79	200

Sedir Düğme

Kod / SM-1193



Saten	Krom	M.Kr.	📦
0.77	0.77	0.79	200

Pırlanta Düğme

Kod / SM-1194



Saten	Krom	M.Kr.	M.Siyah	📦
1.54	1.54	1.54	1.54	100

Gelincik Düğme

Kod / SM-1195



Saten	Krom	M.Kr.	M.Siyah	📦
1.54	1.54	1.54	1.54	100

Hasır Düğme

Kod / SM-1196



Saten	Krom	M.Kr.	📦
0.77	0.77	0.79	200

Noktalı Düğme

Kod / SM-1197



Saten	Krom	M.Kr.	📦
0.77	0.77	0.79	200

Düz Düğme

Kod / SM-1198



Saten	Krom	M.Kr.	📦
0.77	0.77	0.79	200

Baklavalı Düğme

Kod / SM-1199



Saten	Krom	M.Kr.	📦
0.77	0.77	0.79	200

Ç.Baklavalı Düğme

Kod / SM-1200



Saten	Krom	M.Kr.	📦
0.77	0.77	0.79	200

Boğaziçi Düğme

Kod / SM-1201



Saten	Krom	M.Kr.	📦
0.77	0.77	0.79	200

Misket Düğme

Kod / SM-1202



	Saten	Krom	M.Kr.	📦
19 mm	0.77	0.77	0.79	200
25 mm	1.25	1.25	1.30	100

Yeni Düğme

Kod / SM-1203



Saten	Krom	M.Kr.	📦
0.77	0.77	0.79	200

Damla Düğme

Kod / SM-1204



Saten	Krom	M.Kr.	📦
0.77	0.77	0.79	200

Tırnak Düğme

Kod / SM-1205



Saten	Krom	M.Kr.	📦
0.77	0.77	0.79	200

Mermi Düğme

Kod / SM-1206



Saten	Krom	M.Kr.	📦
0.74	0.74	0.77	200

32 Y.Ay Düğme

Kod / SM-1207



Saten	Krom	M.Kr.	📦
0.77	0.77	0.79	200

Set Düğme

Kod / SM-1208



Saten	Krom	M.Kr.	📦
0.77	0.77	0.79	200

Ay Düğme

Kod / SM-1209



Saten	Krom	M.Kr.	📦
0.77	0.77	0.79	200

Sedef Düğme

Kod / SM-1210



Saten	Krom	M.Kr.	📦
0.77	0.77	0.79	200

Düz Kare Düğme

Kod / SM-1211



Saten	Krom	M.Kr.	📦
1.02	1.14	1.02	300

Kareli Düğme

Kod / SM-1212



Saten	Krom	M.Kr.	📦
1.02	1.14	1.02	300

Stil Düğme

Kod / SM-1213



Saten	Krom	M.Kr.	📦
1.02	1.14	1.02	300

Çizgili Düğme

Kod / SM-1214



A.Bakır	A.Sarı	📦
0.74	0.74	200

Üzümlü Düğme

Kod / SM-1215



A.Bakır	A.Sarı	📦
0.74	0.74	200

Çizgili Sallama

Kod / SM-1216



A.Bakır	A.Sarı	📦
0.77	0.77	200

Üzümlü Sallama

Kod / SM-1217



A.Bakır	A.Sarı	📦
0.77	0.77	200

64 Çizgili Antik

Kod / SM-1218



A.Bakır	A.Sarı	📦
1.44	1.44	150

64 Üzümlü Antik

Kod / SM-1219



A.Bakır	A.Sarı	📦
1.25	1.25	150

Gerdan Düğme

Kod / SM-1220



A.Bakır	A.Sarı	📦
0.74	0.74	200

Gerdan Sallama

Kod / SM-1221



A.Bakır	A.Sarı	📦
0.74	0.74	200

Boğaziçi Düğme

Kod / SM-1222



A.Bakır	A.Sarı	📦
0.74	0.74	200

Hasır Düğme

Kod / SM-1223



A.Bakır	A.Sarı	📦
0.74	0.74	200

Küçük Boğaziçi

Kod / SM-1224



A.Bakır	A.Sarı	📦
1.30	1.30	200

Hasır Sallama

Kod / SM-1225



A.Bakır	A.Sarı	📦
0.77	0.77	150

Büyük Boğaziçi

Kod / SM-1226



A.Bakır	A.Sarı	📦
1.44	1.44	100

64 Hasır Antik

Kod / SM-1227



A.Bakır	A.Sarı	📦
1.44	1.44	150

64 Boğaziçi

Kod / SM-1228



A.Bakır	A.Sarı	📦
1.16	1.16	150

Ay Sallama

Kod / SM-1229



A.Bakır	A.Sarı	📦
0.74	0.74	200

Damla Dügme

Kod / SM-1230



A. Bakır	A. Sarı	☐
0.74	0.74	200

64 U Sallantı

Kod / SM-1231



A. Bakır	A. Sarı	☐
1.35	1.35	150

Damla Sallama

Kod / SM-1232



A. Bakır	A. Sarı	☐
0.77	0.77	200

64 U Papucu

Kod / SM-1233



A. Bakır	A. Sarı	☐
1.35	1.35	150

64 Damla

Kod / SM-1234



A. Bakır	A. Sarı	☐
1.44	1.44	150

96 U Papucu

Kod / SM-1235



A. Bakır	A. Sarı	☐
1.54	1.54	100

Çiçek Sallama

Kod / SM-1236



A. Bakır	A. Sarı	☐
0.72	0.72	200

Lale Sallama

Kod / SM-1237



A. Bakır	A. Sarı	☐
0.72	0.72	200

Kalp Düğme

Kod / SM-1238



A.Bakır	A.Sarı	📦
0.74	0.74	200

Kalp Sallama

Kod / SM-1239



A.Bakır	A.Sarı	📦
0.74	0.74	200

Misket Düğme

Kod / SM-1240



A.Bakır	A.Sarı	📦
0.74	0.74	200

Misket Sallama

Kod / SM-1241



A.Bakır	A.Sarı	📦
0.74	0.74	200

Papyon Düğme

Kod / SM-1242



A.Bakır	A.Sarı	📦
0.74	0.74	200

Papatya Düğme

Kod / SM-1243



A.Bakır	A.Sarı	📦
0.74	0.74	200

Zirve Düğme

Kod / SM-1244



A.Bakır	A.Sarı	📦
0.74	0.74	200

Kelebek Mentеше

Kod / SM-1245



	A.Bakır	A.Sarı	📦
Küçük	0.68	0.68	400
Büyük	0.82	0.82	200



Flora Kulp

Kod / SM-1246

Ölçü	64 mm	96 mm	128 mm	160 mm	192 mm
Şeffaf Krom	14.50	18.75	22.50	28.75	33.75
Şeffaf Altın	15.75	19.75	24.00	30.25	35.65
☒	50	50	50	50	50

Ölçü	64 mm	96 mm	128 mm	160 mm	192 mm
Renkli Krom	16.25	23.15	27.50	35.00	42.25
Renkli Altın	18.00	24.63	29.50	37.30	42.75
☒	50	50	50	50	50



Küre Düğme

Kod / SM-1247

Ölçü	20 mm	30 mm	40 mm
Şeffaf Krom	3.50	3.50	6.25
Şeffaf Altın	3.88	3.88	6.63
Renkli Krom	5.45	7.00	10.93
Renkli Altın	6.13	7.65	11.58
☒	50	50	50



Oscar Düğme

Kod / SM-1248

Ölçü	30 mm	40 mm
Şeffaf Krom	7.50	12.50
Şeffaf Altın	8.38	13.75
Renkli Krom	11.00	12.00
Renkli Altın	16.50	18.75
☒	50	50

Misket Düğme

Kod / SM-1249



Ölçü	30 mm	40 mm
Şeffaf Krom	4.38	8.75
Şeffaf Altın	4.75	10.00
☒	50	50

Benekli Düğme

Kod / SM-1250



Ölçü	30 mm
Şeffaf Krom	5.63
Şeffaf Altın	5.85
Renkli Krom	10.00
Renkli Altın	10.75
☒	50

Ufo Dügme

Kod / SM-1251



Ölçü	Şeffaf Krom	Şeffaf Altın	Renkli Krom	Renkli Altın	☒
30 mm	3.63	4.00	6.33	7.00	50
40 mm	4.00	4.38	7.50	8.25	50

Elmas Dügme

Kod / SM-1252



Ölçü	Şeffaf Krom	Şeffaf Altın	Renkli Krom	Renkli Altın	☒
20 mm	3.50	3.88	5.45	6.13	50
30 mm	3.63	4.00	6.33	7.00	50
40 mm	4.00	4.38	7.50	8.25	50

Smart Dügme

Kod / SM-1253



Ölçü	Şeffaf Krom	Şeffaf Altın	Renkli Krom	Renkli Altın	☒
30 mm	3.50	3.88	5.45	6.13	50

Kalyon Dügme

Kod / SM-1254



Ölçü	Şeffaf Krom	Şeffaf Altın	Renkli Krom	Renkli Altın	☒
30 mm	3.63	4.00	6.33	7.00	50

Optima Dügme

Kod / SM-1255



Ölçü	Şeffaf Krom	Şeffaf Altın	Renkli Krom	Renkli Altın	☒
30 mm	4.38	4.75	7.65	8.30	50

Point Dügme

Kod / SM-1256



Ölçü	Şeffaf Krom	Şeffaf Altın	Renkli Krom	Renkli Altın	☒
30 mm	4.00	4.38	7.50	8.25	50

Gül Dügme

Kod / SM-1257



Ölçü	Şeffaf Krom	Şeffaf Altın	Renkli Krom	Renkli Altın	☒
30 mm	3.50	3.88	5.45	6.13	50
40 mm	3.75	4.13	6.55	7.20	50

Küp Dügme

Kod / SM-1258

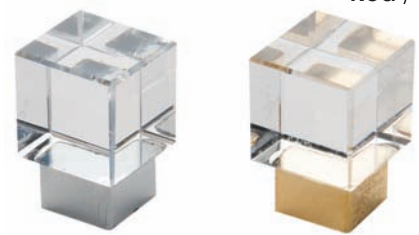

Ölçü	Şeffaf Krom	Şeffaf Altın	Renkli Krom	Renkli Altın	☒
17 mm	3.50	3.88	5.45	6.13	50
20 mm	3.63	4.00	6.33	7.00	50

Motif Aski

Kod / SM-1259



Krom	inox	Sarı	
10.62	12.42	13.77	15

Buse Portmanto

Kod / SM-1260

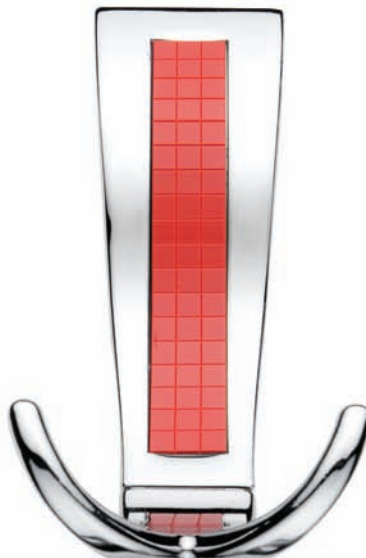
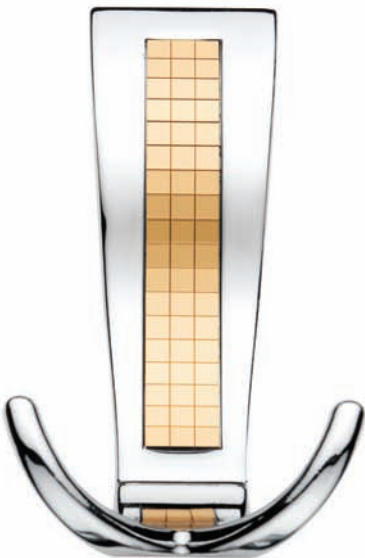

Krom	inox	
7.65	8.19	40

Meriç Portmanto

Kod / SM-1261

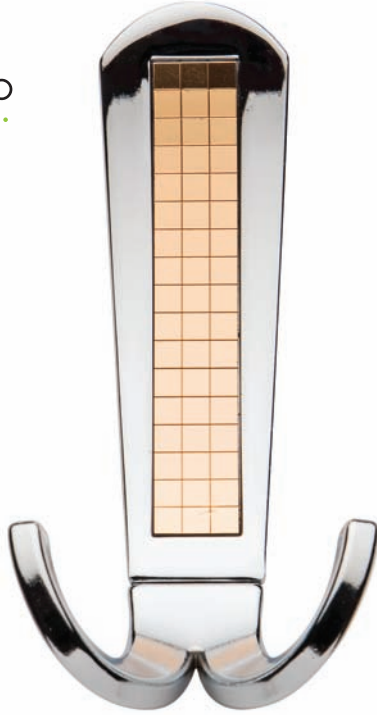

Meriç Askı

Kod / SM-1262



Krom



Beyaz



Kırmızı



Siyah



Füme



Sarı



Galaksi

	Krom	Saten	M.Krom	☐
Askı	4.80	4.80	4.80	50
Portmanto	5.76	5.76	5.76	50

Kristal Portmanto

Kod / SM-1263



Kristal Askı

Kod / SM-1264



	Krom	Saten	M.Krom	☐
Askı	1.54	1.54	1.54	100
Portmanto	2.40	2.40	2.40	50

Beta Portmanto

Kod / SM-1265



Beta Askı

Kod / SM-1266

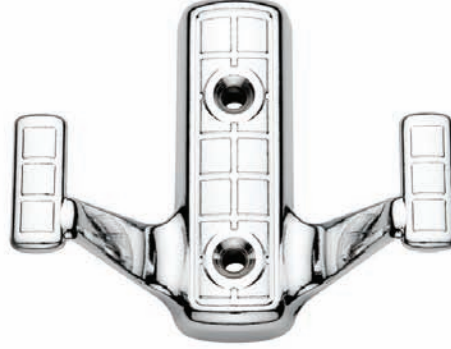

	Krom	Saten	M.Krom	📦
Askı	2.05	2.05	2.05	50
Portmanto	2.97	2.97	2.97	40

Noktalı Portmanto

Kod / SM-1267



Noktalı Askı

Kod / SM-1268



	Krom	Saten	M.Krom	📦
Askı	1.40	1.40	1.40	50
Portmanto	2.22	2.22	2.22	50

Seylan
Portmanto

Kod / SM-1269



Seylan Askı

Kod / SM-1270



	Krom	Saten	M.Krom	📦
Askı	4.32	4.32	4.32	50
Portmanto	5.28	5.28	5.28	50

Narin
Portmanto

Kod / SM-1271



Narin Askı

Kod / SM-1272



	Krom	Saten	M.Krom	📦
Askı	1.35	1.35	1.35	100
Portmanto	2.31	2.31	2.31	50

Kuğu Aski

Kod / SM-1273



Krom	Inox	Kr.Inox	Saten	M.Krom	☒
4.66	4.76	4.76	4.26	4.26	50

Kuğu Portmanto

Kod / SM-1274



Krom	Inox	Kr.Inox	Saten	M.Krom	☒
7.23	7.33	7.33	7.03	7.03	30

Fiko Portmanto

Kod / SM-1275



Fiko Aski

Kod / SM-1276



	Krom	Saten	M.Krom	☒
Aski	1.35	1.35	1.35	100
Portmanto	2.21	2.21	2.21	50

Çınar Portmanto

Kod / SM-1277



Krom	Inox	Kr.Inox	Saten	M.Krom	☒
7.23	7.33	7.33	7.03	7.03	30

Açık
Portmanto

Kod / SM-1278



Açık Askı

Kod / SM-1279



	Krom	Saten	M.Krom	📦
Askı	3.46	3.46	3.46	50
Portmanto	4.40	4.40	4.40	30



Aynalı
Portmanto

Kod / SM-1280



Aynalı Askı

Kod / SM-1281



	Krom	Saten	M.Krom	📦
Askı	3.46	3.46	3.46	50
Portmanto	4.40	4.40	4.40	30

Aris Portmanto

Kod / SM-1282



Aris Askı

Kod / SM-1283



	Krom	Saten	M.Krom	📦
Askı	2.22	2.22	2.22	50
Portmanto	3.54	3.54	3.54	40



Kapalı Portmanto

Kod / SM-1284



	Krom	Saten	M.Krom	📦
	5.36	5.36	5.36	30

Star
Portmanto

Kod / SM-1285



Star Askı

Kod / SM-1286



	Krom	Saten	M.Krom	☐
Askı	1.92	1.92	2.02	100
Portmanto	2.88	2.88	3.08	50

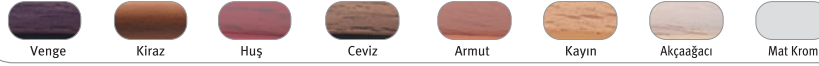

Damla
Portmanto

Kod / SM-1287



Damla Askı

Kod / SM-1288



	Krom	Saten	M.Krom	☐
Askı	1.92	1.92	2.02	100
Portmanto	2.88	2.88	3.08	50

Kardelen Portmanto

Kod / SM-1289



Kardelen Askı

Kod / SM-1290



	Krom	Saten	M.Krom	☐
Askı	1.92	1.92	2.02	100
Portmanto	2.88	2.88	3.08	50



Yaprak Portmanto

Kod / SM-1291



Yaprak Askı

Kod / SM-1292



	Krom	Saten	M.Krom	☐
Askı	1.92	1.92	2.02	100
Portmanto	2.88	2.88	3.08	50

Stella Aski

Kod / SM-1293



Krom	Saten	M.Krom	☐
4.70	4.70	4.70	30

Yelken Aski

Kod / SM-1294



Krom	Saten	M.Krom	☐
1.92	1.92	2.02	100

Ayder Aski

Kod / SM-1295



Krom	Saten	M.Krom	☐
1.92	1.92	2.02	50

Stil Aski

Kod / SM-1296



Krom	Saten	M.Krom	☐
3.82	3.82	3.82	50

Dilay Aski

Kod / SM-1297



Krom	Saten	M.Krom	☐
1.92	1.92	2.02	100



Eta Portmanto

Kod / SM-1298



Krom	Saten	M.Krom	📦
2.21	2.21	2.21	50

Üçgen Portmanto

Kod / SM-1299



Krom	Saten	M.Krom	📦
2.21	2.21	2.21	50

Klasik Portmanto

Kod / SM-1300



Krom	Saten	M.Krom	📦
2.21	2.21	2.21	50

Pelikan Portmanto

Kod / SM-1301



Krom	Saten	M.Krom	📦
2.88	2.88	2.88	50

Çizgili Askı

Kod / SM-1302



Krom	Saten	M.Krom	📦
1.35	1.35	1.35	100

Sarıklı Askı

Kod / SM-1303



Krom	Saten	M.Krom	📦
1.35	1.35	1.35	100

Kemerli Askı

Kod / SM-1304



Krom	Saten	M.Krom	📦
1.35	1.35	1.35	100

Kobra Askı

Kod / SM-1305



Krom	Saten	M.Krom	📦
1.35	1.35	1.35	100

Klasik Askı

Kod / SM-1306



Krom	Saten	M.Krom	📦
1.15	1.15	1.15	100

Lale Askı

Kod / SM-1307



Krom	Saten	M.Krom	📦
1.15	1.15	1.15	100



B.Kurbağa Askı

Kod / SM-1308

Krom	1.15
Saten	1.15
M.Krom	1.15
☒	100



K.Kurbağa Askı

Kod / SM-1309

Krom	0.91
Saten	0.91
M.Krom	0.91
☒	200



Roket Askı

Kod / SM-1310

Krom	0.91
Saten	0.91
M.Krom	0.91
☒	200



Tekli Yelpaze Askı

Kod / SM-1311

Krom	1.06
Saten	1.06
M.Krom	1.06
☒	100



Tekli Kupa Askı

Kod / SM-1312

Krom	1.06
Saten	1.06
M.Krom	1.06
☒	100



Tekli Yaprak Askı

Kod / SM-1313

Krom	1.06
Saten	1.06
M.Krom	1.06
☒	100



Tekli Askı

Kod / SM-1314

Krom	1.06
Saten	1.06
M.Krom	1.06
☒	100



Tekli Başak Askı

Kod / SM-1315

Krom	1.06
Saten	1.06
M.Krom	1.06
☒	100

www.simaaksesuar.com

Alm.Sütun Ayak

Kod / SM-1316



	6 cm	8 cm	10 cm
Inox	2.70	2.90	3.10
📦	225	300	250

Alm.Sütun Ayak

Kod / SM-1317



	6 cm	8 cm	10 cm
Beyaz	2.70	2.90	3.10
📦	225	300	250

Alm.Sütun Ayak

Kod / SM-1318



	6 cm	8 cm	10 cm
Siyah	2.70	2.90	3.10
📦	225	300	250

Alm.Kare Çizgili Ayak

Kod / SM-1319



	M.Krom	inox	📦
5 cm	2.28	2.40	100
8 cm	2.52	2.64	100
10 cm	2.76	2.88	100
12 cm	3.12	3.36	100
15 cm	3.60	3.84	50
20 cm	4.56	4.80	50

Alm.Kare Düz Ayak

Kod / SM-1320



	M.Krom	inox	Krom	📦
5 cm	2.28	2.40	4.08	100
8 cm	2.52	2.64	4.68	100
10 cm	2.76	2.88	5.48	100
12 cm	3.12	3.36	6.12	100
15 cm	3.60	3.84	7.64	50
20 cm	4.56	4.80	9.08	50

Alm.Yuvarlak Çizgili Ayak

Kod / SM-1321



	M.Krom	📦
5 cm	2.40	100
8 cm	2.64	100
10 cm	2.88	100
12 cm	3.24	100
15 cm	3.84	50
20 cm	4.80	50

Alm.Yuvarlak Düz Ayak

Kod / SM-1322



	M.Krom	📦
5 cm	2.40	100
8 cm	2.64	100
10 cm	2.88	100
12 cm	3.24	100
15 cm	3.84	50
20 cm	4.80	50

Sunta Destek Ayak

Kod / SM-1323



	M.Krom	📦
5 cm	2.76	200
8 cm	3.32	150
10 cm	3.61	100
12 cm	4.14	100
15 cm	4.90	80
20 cm	5.83	70

Alm.Tuğra Ayak

Kod / SM-1324



	M.Krom	inox	📦
6 cm	2.12	2.28	100
8 cm	2.31	2.52	90
10 cm	2.64	2.88	80



Kupa Kemerli Ayak

Kod / SM-1325

	8 cm	10 cm
Krom Bingo	2.10	2.20
	300	250



Kupa Kemerli Ayak

Kod / SM-1326

	8 cm	10 cm
M.Kr.Bingo	1.90	2.00
	300	250



Kupa Kemerli Ayak

Kod / SM-1327

	8 cm	10 cm
Siyah	2.10	2.20
	300	250

Efe Ayak

Kod / SM-1328



	M.Krom	📦
6 cm	1.92	100
8 cm	2.04	90
10 cm	2.16	80

Sırma Ayak

Kod / SM-1329



	M.Krom	📦
6 cm	1.30	200
8 cm	1.45	200
10 cm	1.58	200

Elvin Ayak

Kod / SM-1330



	M.Krom	📦
6 cm	1.30	200
8 cm	1.45	200
10 cm	1.58	200

Aksel Ayak

Kod / SM-1331



	M.Krom	📦
6 cm	1.30	200
8 cm	1.45	200
10 cm	1.58	200

River Ayak

Kod / SM-1332



	M.Krom	📦
5 cm	1.70	210
8 cm	1.80	140
10 cm	1.90	105

Pls.Sütun Ayak

Kod / SM-1333



	M.Krom	📦
5 cm	1.10	400
8 cm	1.10	200
10 cm	1.10	200



Tombul Ayak
Kod / SM-1334

	Krom	M.Krom	Saten	📦
10 cm	2.42	1.38	1.38	100



Konik Ayak
Kod / SM-1335

	Krom	M.Krom	Saten	📦
5 cm	1.84	1.00	1.00	200
8 cm	1.84	1.00	1.00	150
10 cm	2.16	1.06	1.06	125



Köşe Ayak
Kod / SM-1336

	M.Krom	Saten	📦
6.5 cm	0.89	0.89	300



Kare Ayak
Kod / SM-1337

	M.Krom	Saten	📦
3 cm	1.80	1.80	200



L Ayak
Kod / SM-1338

	Krom	M.Krom	Saten	📦
4 cm	4.29	1.65	1.65	225



Üçgen Ayak
Kod / SM-1339

	Krom	M.Krom	Saten	📦
3 cm	1.60	1.06	1.06	500

Lükens Ayak

Kod / SM-1340



	Beyaz	Siyah	M.Krom	A.Varak	📦
14 cm	2.67	2.67	3.90	4.52	85
20 cm	6.98	6.98	8.21	9.75	35

Motifli Lükens Ayak

Kod / SM-1341



	Beyaz	Siyah	M.Krom	A.Varak	📦
14 cm	5.75	5.75	6.93	8.00	50

Lüx L Ayak

Kod / SM-1342



	Krom	Saten	M.Krom	A.Desen	📦
4.5 cm	6.90	6.90	6.90	6.90	100

Küre Kemerli Ayak

Kod / SM-1343

Ø 85 mm



	Beyaz	Siyah	M.Krom	A.Varak	📦
8 cm	2.26	2.26	2.46	2.67	150

Tombul Küre Ayak

Kod / SM-1344

Ø 90 mm



	Beyaz	Siyah	M.Krom	A.Varak	📦
7 cm	1.95	1.95	2.26	2.36	150

Jumbo Küre Ayak

Kod / SM-1345

Ø 140 mm



	Beyaz	Siyah	M.Krom	A.Varak	📦
10 cm	7.70	7.70	8.21	8.73	50



Ayarlı Baza Ayağı

Kod / SM-1346

	10 x15
Beyaz	0.45
	250



Baza Ayağı

Kod / SM-1347

	Beyaz	
8 cm	0.33	300
10 cm	0.33	300
12 cm	0.37	300
15 cm	0.40	300

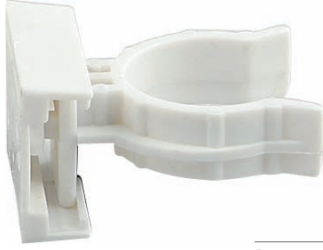

Baza Klipsi

Kod / SM-1348

	10 x10	10 x 15
Beyaz	0.11	0.12
	300	300



Vazo Ayak

Kod / SM-1349

	5 cm
Pls.Renkler	0.675
	250



Kupa Ayak

Kod / SM-1350

	5 cm
Pls.Renkler	0.415
	300



Gül Ayak

Kod / SM-1351

	10 cm
Pls.Renkler	0.436
	300



Köşe Ayak

Kod / SM-1352

	Fiyat
Pls.Renkler	0.41
	100



Sofra Ayağı

Kod / SM-1353

	Fiyat
Siyah/Beyaz	0.94
	100

Motif Ayak

Kod / SM-1354



	10 cm
Krom	5.92
	200

Desenli Ayak

Kod / SM-1357



	Krom	Inox	Sari
10 cm	13.5	15.21	17.01
	12	12	12

Ø51 Zirve Ayak M.8

Kod / SM-1355



	Krom	
5 cm	2.69	80
8 cm	3.03	70
10 cm	3.29	60

Ø51 Zirve Ayak M.10

Kod / SM-1356



	Krom	
5 cm	2.84	80
8 cm	3.24	70
10 cm	3.51	60

Konik Ayak

Kod / SM-1358



	Krom	Saten	
5 cm	2.02	1.59	400
8 cm	2.36	1.92	300
10 cm	2.50	2.12	250

Karya Ayak

Kod / SM-1359



	Krom	Saten	M.Krom	
12 cm	9.10	9.10	9.10	60

Eğik Ayak

Kod / SM-1360



	Krom	Saten	M.Krom	
10 cm	6.54	6.54	6.54	80

Esterya Ayak

Kod / SM-1361



	Krom	Saten	M.Krom	
12 cm	7.65	7.65	7.65	60

Alara Ayak

Kod / SM-1362



	Krom	Saten	M.Krom	
10 cm	5.97	5.97	5.97	80

Atlas Ayak

Kod / SM-1363



	Krom	Saten	M.Krom	
10 cm	3.36	3.36	3.36	150

Kıvrık Ayak

Kod / SM-1364



	Krom	Saten	M.Krom	
12 cm	3.08	2.64	2.64	200

32 mm Plastik Bingolu Baza Ayağı

Kod / SM-1365



	6 cm	8 cm	10 cm	12 cm	15 cm	20 cm
Krom	2.28	2.40	2.61	2.89	3.17	3.64
Saten/M.Krom	2.16	2.28	2.40	2.65	2.88	3.24
📦	100	100	100	72	72	60

42 mm Plastik Bingolu Baza Ayağı

Kod / SM-1366



	6 cm	8 cm	10 cm	12 cm	15 cm	20 cm
Krom	2.45	2.57	2.75	3.04	3.33	3.94
Saten/M.Krom	2.22	2.37	2.49	2.74	3.07	3.59
📦	100	100	100	72	72	36

51 mm Plastik Bingolu Baza Ayağı

Kod / SM-1367



	6 cm	8 cm	10 cm	12 cm	15 cm	20 cm
Krom	2.77	3.09	3.38	3.62	4.12	4.90
Saten/M.Krom	2.50	2.78	3.04	3.26	3.71	4.42
☐	60	80	64	44	44	32

60 mm Plastik Bingolu Baza Ayağı

Kod / SM-1368



	6 cm	8 cm	10 cm	12 cm	15 cm	20 cm
Krom	2.92	3.25	3.56	3.81	4.34	5.17
Saten/M.Krom	2.63	2.93	3.20	3.44	3.90	4.65
☐	60	80	64	44	44	32

42 mm Gri Pls.Bingolu Baza Ayağı

Kod / SM-1369



	6 cm	8 cm	10 cm	12 cm	15 cm	20 cm
Krom	2.30	2.50	2.61	2.90	3.34	3.92
Saten/M.Krom	2.11	2.25	2.40	2.66	3.15	3.62
📦	100	100	100	72	72	36

42 mm Üstten Ayarlı Baza Ayağı

Kod / SM-1370



	6 cm	8 cm	10 cm	12 cm	15 cm	20 cm
Krom	2.95	3.13	3.27	3.66	4.03	4.57
Saten/M.Krom	2.65	2.82	2.95	3.29	3.62	4.11
📦	88	100	100	80	72	48

32 mm Metal Bingolu Baza Ayağı

Kod / SM-1371



	6 cm	8 cm	10 cm	12 cm	15 cm	20 cm
Krom	2.96	3.33	3.42	3.61	3.99	4.37
Saten/M.Krom	2.68	2.80	3.08	3.25	3.59	3.93
📦	88	100	100	72	72	48

42 mm Metal Bingolu Baza Ayağı

Kod / SM-1372



	6 cm	8 cm	10 cm	12 cm	15 cm	20 cm
Krom	3.72	3.86	4.04	4.37	4.75	5.36
Saten/M.Krom	3.52	3.64	3.84	4.07	4.41	4.95
📦	88	100	100	64	64	48

51 mm Metal Bingolu Baza Ayağı

Kod / SM-1373



	6 cm	8 cm	10 cm	12 cm	15 cm	20 cm
Krom	4.70	4.89	5.13	5.51	5.89	6.75
Saten/M.Krom	4.30	4.52	4.75	5.13	5.51	6.25
📦	48	72	64	44	44	32

60 mm Metal Bingolu Baza Ayağı

Kod / SM-1374



	6 cm	8 cm	10 cm	12 cm	15 cm	20 cm
Krom	5.04	5.13	5.42	5.85	6.27	7.03
Saten/M.Krom	4.66	4.90	5.13	5.53	5.93	6.65
📦	48	72	48	36	36	24

32 mm Raf Ara Bağlantı

Kod / SM-1375



	5 cm	10 cm	15 cm	20 cm	25 cm	30 cm	35 cm	40 cm
Krom	3.34	3.52	4.09	4.67	5.23	5.64	6.08	6.52
Saten/M.Krom	3.17	3.34	3.68	4.20	4.71	5.08	5.47	5.87
📦	100	48	48	48	48	48	40	40

42 mm Raf Ara Bağlantı

Kod / SM-1376



	5 cm	10 cm	15 cm	20 cm	25 cm	30 cm	35 cm	40 cm
Krom	3.59	4.14	4.85	5.13	5.70	6.18	6.65	7.22
Saten/M.Krom	3.53	3.91	4.37	4.62	5.13	5.56	5.99	6.50
📦	100	72	48	40	48	48	40	36

51 mm Raf Ara Bağlantı

Kod / SM-1377



	5 cm	10 cm	15 cm	20 cm	25 cm	30 cm	35 cm	40 cm
Krom	3.90	4.66	5.42	6.27	6.90	7.60	8.27	9.00
Saten/M.Krom	3.82	4.33	4.88	5.64	6.21	6.84	7.44	8.10
📦	50	36	48	48	36	36	32	32

60 mm Raf Ara Bağlantı

Kod / SM-1378



	5 cm	10 cm	15 cm	20 cm	25 cm	30 cm	35 cm	40 cm
Krom	4.37	5.23	6.08	6.56	7.47	8.25	9.16	9.90
Saten/M.Krom	4.33	4.92	5.47	5.90	6.72	7.43	8.24	8.91
📦	36	36	44	36	28	24	20	20

Metal Bingolar

Kod / SM-1379



	Krom	Saten	M.Krom	
55 mm	1.18	1.18	1.18	100
65 mm	1.37	1.37	1.37	100
75 mm	1.55	1.55	1.55	100

Masa Ayağı

Kod / SM-1380



Ø 60	Krom	Saten	M.Krom	
71 cm	11.50	11.00	11.00	4

Keson Kapakları

Kod / SM-1381



	Krom	Saten	M.Krom	
35 mm	1.62	1.46	1.46	100
45 mm	2.24	2.00	2.00	100
65 mm	3.19	2.88	2.88	100

Sehpa Ayağı

Kod / SM-1382



Ø 60	Krom	Saten	M.Krom	
41 cm	10.50	10.00	10.00	4

Keson Kelebekler

Kod / SM-1383



	32 mm	42 mm	51 mm	60 mm
Çinko	0.37	0.53	0.68	0.83
	100	100	100	100

Ø38 Yuvarlak Taban

Kod / SM-1384



	Krom	Saten	M.Krom	T.Lastığı	☐
Eko 2 mm	40.00	36.00	36.00	5.40	4
Lüks 3 mm	48.11	43.33	43.33	5.40	4

Ø48 Yuvarlak Taban

Kod / SM-1385



	Krom	Saten	M.Krom	T.Lastığı	☐
Eko 2 mm	55.35	49.81	49.81	6.00	4
Lüks 3 mm	65.10	58.60	58.60	6.00	4

Ortadan Sehpa ve Masa Ayağı Boruları

Kod / SM-1386



Yuvarlak	Krom	Saten	M.Krom	☐
Ø 60 x 38	9.83	7.99	7.99	4
Ø 60 x 68	15.78	11.59	11.59	4
Ø 76 x 38	15.41	13.00	13.00	4
Ø 76 x 68	24.40	18.69	18.69	4

Kare	Krom	Saten	M.Krom	☐
▣ 60 x 38	28.19	26.78	26.78	4
▣ 60 x 68	36.54	34.72	34.72	4
▣ 80 x 38	37.59	35.71	35.71	4
▣ 80 x 68	44.90	42.65	42.65	4

Kare Tabanlar

Kod / SM-1387



	Krom	Saten	M.Krom	T.Lastığı	☐
40 x 40 / 3 mm	59.91	53.92	53.92	7.20	4
50 x 50 / 3 mm	78.55	70.70	70.70	8.40	4

Paslanmaz Flanşlar

Kod / SM-1388



	Fiyat	☐
Ø 35	3.45	100
Ø 45	3.82	100
Ø 55	4.96	100
Ø 65	5.93	50
Ø 80	10.35	50

Üst Tablalar

Kod / SM-1389

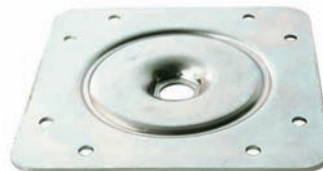

	Çinko	☐
10 x 10	1.40	4
19 x 19	7.35	4

Tablalı



Kod	Açıklama	Gri	☒
SM-1390	50 x 20 Tablalı	4.08	100
SM-1391	50 x 20 Tablalı Frenli	5.28	80
SM-1392	75 x 25 Tablalı	5.76	45
SM-1393	75 x 25 Tablalı Frenli	6.96	40

Tablalı



Kod	Açıklama	Şeffaf	☒
SM-1402	50 x 20 Tablalı	4.80	100
SM-1403	50 x 20 Tablalı Frenli	6.00	80
SM-1404	75 x 25 Tablalı	7.68	45
SM-1405	75 x 25 Tablalı Frenli	8.88	40

Vidalı



Kod	Açıklama	Gri	☒
SM-1394	50 x 20 Vidalı	3.84	125
SM-1395	50 x 20 Vidalı Frenli	5.04	90
SM-1396	75 x 25 Vidalı	5.28	60
SM-1397	75 x 25 Vidalı Frenli	6.48	45

Vidalı



Kod	Açıklama	Şeffaf	☒
SM-1406	50 x 20 Vidalı	4.56	125
SM-1407	50 x 20 Vidalı Frenli	5.76	90
SM-1408	75 x 25 Vidalı	7.44	60
SM-1409	75 x 25 Vidalı Frenli	8.64	45

U Tablalı



Kod	Açıklama	Gri	☒
SM-1398	50 x 20 U Tablalı	4.08	140
SM-1399	50 x 20 U Tablalı Frenli	5.28	100
SM-1400	75 x 25 U Tablalı	5.76	70
SM-1401	75 x 25 U Tablalı Frenli	6.96	50

U Tablalı



Kod	Açıklama	Şeffaf	☒
SM-1410	50 x 20 U Tablalı	4.80	140
SM-1411	50 x 20 U Tablalı Frenli	6.00	100
SM-1412	75 x 25 U Tablalı	7.68	70
SM-1413	75 x 25 U Tablalı Frenli	8.88	50

Tablalı



Kod	Açıklama	Siyah	📦
SM-1414	50 x 20 Tablalı	3.60	100
SM-1415	50 x 20 Tablalı Frenli	4.80	80
SM-1416	75 x 25 Tablalı	5.28	45
SM-1417	75 x 25 Tablalı Frenli	6.48	40

Tablalı



Kod	Açıklama	Fiyat	📦
SM-1426	50 x 20 Tablalı Gri	2.28	150
SM-1427	50 x 20 Tablalı Şeffaf	2.52	150
SM-1428	50 x 20 Tablalı Siyah	2.04	150

Vidalı



Kod	Açıklama	Siyah	📦
SM-1418	50 x 20 Vidalı	3.36	125
SM-1419	50 x 20 Vidalı Frenli	4.56	90
SM-1420	75 x 25 Vidalı	4.80	60
SM-1421	75 x 25 Vidalı Frenli	6.00	45

Vidalı

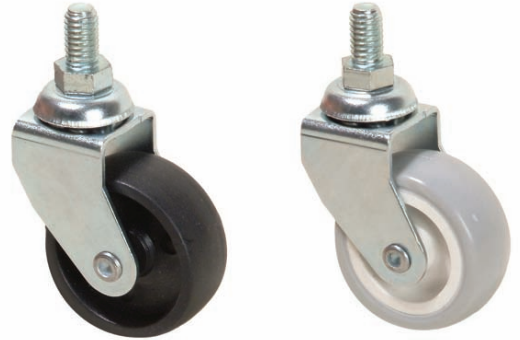

Kod	Açıklama	Fiyat	📦
SM-1429	50 x 20 Vidalı Gri	2.28	150
SM-1430	50 x 20 Vidalı Şeffaf	2.52	150
SM-1431	50 x 20 Vidalı Siyah	2.04	150

U Tablalı



Kod	Açıklama	Siyah	📦
SM-1422	50 x 20 U Tablalı	3.60	140
SM-1423	50 x 20 U Tablalı Frenli	4.80	100
SM-1424	75 x 25 U Tablalı	5.28	70
SM-1425	75 x 25 U Tablalı Frenli	6.48	50

U Tablalı



Kod	Açıklama	Fiyat	📦
SM-1432	50 x 20 U Tablalı Gri	2.40	150
SM-1433	50 x 20 U Tablalı Şeffaf	2.64	150
SM-1434	50 x 20 U Tablalı Siyah	2.16	150

Renkli Tablalı



Kod	Açıklama	Gri	☐
SM-1435	50 mm Tablalı	2.76	250
SM-1436	50 mm Tablalı Frenli	3.12	250
SM-1437	75 mm Tablalı	8.04	100
SM-1438	75 mm Tablalı Frenli	9.00	100

Küre Tablalı



Kod	Açıklama	Fiyat	☐
SM-1447	40 mm Küre Tablalı Gri	2.28	150
SM-1448	40 mm Küre Tablalı Siyah	2.04	150

Renkli Vidalı



Kod	Açıklama	Gri	☐
SM-1439	50 mm Vidalı	2.64	250
SM-1440	50 mm Vidalı Frenli	3.00	250
SM-1441	75 mm Vidalı	7.92	100
SM-1442	75 mm Vidalı Frenli	8.88	100

Küre Vidalı



Kod	Açıklama	Fiyat	☐
SM-1449	40 mm Küre Vidalı Gri	2.28	200
SM-1450	40 mm Küre Vidalı Siyah	2.04	200

Renkli Pimli



Kod	Açıklama	Gri	☐
SM-1443	50 mm Pimli	2.76	250
SM-1444	50 mm Pimli Frenli	3.12	250
SM-1445	75 mm Pimli	8.04	100
SM-1446	75 mm Pimli Frenli	9.00	100

Küre U Tablalı



Kod	Açıklama	Fiyat	☐
SM-1451	40 mm Küre U Tablalı Gri	2.40	150
SM-1452	40 mm Küre U Tablalı Siyah	2.16	150

Büro Tablalı



Kod	Açıklama	Fiyat	☐
SM-1453	50 mm Büro Tablalı Gri	1.86	250
SM-1454	50 mm Büro Tablalı Siyah	1.62	250

Büro Kalın Pimli



Kod	Açıklama	Fiyat	☐
SM-1459	50 mm Büro K.Pimli Gri	1.86	250
SM-1460	50 mm Büro K.Pimli Siyah	1.62	250

Büro Vidalı



Kod	Açıklama	Fiyat	☐
SM-1455	50 mm Büro Vidalı Gri	1.74	250
SM-1456	50 mm Büro Vidalı Siyah	1.50	250

Sabit Teker



Kod	Açıklama	Fiyat	☐
SM-1461	28 x 14 Sabit Siyah	0.65	750
SM-1462	32 x 14 Sabit Siyah	0.72	600
SM-1463	38 x 14 Sabit Siyah	0.83	500
SM-1464	50 x 20 Sabit Siyah	1.44	300

Büro U Tablalı



Kod	Açıklama	Fiyat	☐
SM-1457	50 mm Büro U Tablalı Gri	1.98	200
SM-1458	50 mm Büro U Tablalı Siyah	1.74	200

Sabit Teker



Kod	Açıklama	Fiyat	☐
SM-1465	60 x 20 Sabit Gri	1.92	250
SM-1466	60 x 20 Sabit Siyah	1.74	250
SM-1467	75 x 25 Sabit Gri	3.84	60
SM-1468	75 x 25 Sabit Siyah	3.60	60

Tablalı



Kod	Açıklama	Fiyat	📦
SM-1469	40 mm Tablalı Siyah	0.77	250
SM-1470	40 mm Tablalı Gri	0.92	250
SM-1471	50 mm Tablalı Siyah	1.01	250
SM-1472	50 mm Tablalı Gri	1.19	250

Tablalı Frenli



Kod	Açıklama	Fiyat	📦
SM-1481	40 mm Tablalı Siyah	1.20	500
SM-1482	40 mm Tablalı Gri	1.40	500
SM-1483	50 mm Tablalı Siyah	1.74	250
SM-1484	50 mm Tablalı Gri	1.98	250

Vidalı



Kod	Açıklama	Fiyat	📦
SM-1473	40 mm Vidalı Siyah	0.72	250
SM-1474	40 mm Vidalı Gri	0.87	250
SM-1475	50 mm Vidalı Siyah	0.96	250
SM-1476	50 mm Vidalı Gri	1.14	250

Vidalı Frenli



Kod	Açıklama	Fiyat	📦
SM-1485	40 mm Vidalı Frenli Siyah	1.08	500
SM-1486	40 mm Vidalı Frenli Gri	1.28	500
SM-1487	50 mm Vidalı Frenli Siyah	1.62	250
SM-1488	50 mm Vidalı Frenli Gri	1.86	250

U Tablalı



Kod	Açıklama	Fiyat	📦
SM-1477	40 mm U Tablalı Siyah	1.20	250
SM-1478	40 mm U Tablalı Gri	1.35	250
SM-1479	50 mm U Tablalı Siyah	1.38	250
SM-1480	50 mm U Tablalı Gri	1.56	250

U Tablalı Frenli



Kod	Açıklama	Fiyat	📦
SM-1489	40 mm U Tablalı Frenli Siyah	1.44	400
SM-1490	40 mm U Tablalı Frenli Gri	1.64	400
SM-1491	50 mm U Tablalı Frenli Siyah	1.98	200
SM-1492	50 mm U Tablalı Frenli Gri	2.22	200

www.simaaksesuar.com





Cemre
Kod / SM-1493



	Oda	Yale	WC	Rozet Oda	Rozet Yale	Rozet WC
Alb.Saten	11.58	11.58	13.90	16.22	16.22	18.53
Mat Nikel	11.58	11.58	13.90	16.22	16.22	18.53
Saten	11.58	11.58	13.90	16.22	16.22	18.53
📦	2	2	2	5	5	4



Kobra
Kod / SM-1494



	Oda	Yale	WC	Rozet Oda	Rozet Yale	Rozet WC
Alb.Saten	13.20	13.20	15.52	17.84	17.84	20.15
Mat Nikel	13.20	13.20	15.52	17.84	17.84	20.15
Saten	13.20	13.20	15.52	17.84	17.84	20.15
📦	2	2	2	5	5	4

Yaprak
Kod / SM-1495



	Oda	Yale	WC	Rozet Oda	Rozet Yale	Rozet WC
Alb.Saten	11.06	11.06	13.16	15.80	15.80	17.90
Mat Nikel	11.06	11.06	13.16	15.80	15.80	17.90
Saten	11.06	11.06	13.16	15.80	15.80	17.90
📦	2	2	2	5	5	4

Tombik
Kod / SM-1496



	Oda	Yale	WC	Rozet Oda	Rozet Yale	Rozet WC
Alb.Saten	11.06	11.06	13.16	15.80	15.80	17.90
Mat Nikel	11.06	11.06	13.16	15.80	15.80	17.90
Saten	11.06	11.06	13.16	15.80	15.80	17.90
📦	2	2	2	5	5	4



Orkide

Kod / SM-1497



	Oda	Yale	WC	Rozet Oda	Rozet Yale	Rozet WC
Alb.Saten	18.95	18.95	21.06	23.16	23.16	25.48
Mat Nikel	18.95	18.95	21.06	23.16	23.16	25.48
Saten	18.95	18.95	21.06	23.16	23.16	25.48
📦	2	2	2	5	5	4



Zambak

Kod / SM-1498



	Oda	Yale	WC	Rozet Oda	Rozet Yale	Rozet WC
Alb.Saten	10.53	10.53	12.64	15.27	15.27	17.37
Mat Nikel	10.53	10.53	12.64	15.27	15.27	17.37
Saten	10.53	10.53	12.64	15.27	15.27	17.37
📦	2	2	2	5	5	4



Bravo
Kod / SM-1499



	Oda	Yale	WC	Rozet Oda	Rozet Yale	Rozet WC
Alb.Saten	10.53	10.53	12.64	15.27	15.27	17.37
Mat Nikel	10.53	10.53	12.64	15.27	15.27	17.37
Saten	10.53	10.53	12.64	15.27	15.27	17.37
📦	2	2	2	5	5	4



Irmak
Kod / SM-1500



	Oda	Yale	WC	Rozet Oda	Rozet Yale	Rozet WC
Alb.Saten	11.06	11.06	13.16	15.80	15.80	17.90
Mat Nikel	11.06	11.06	13.16	15.80	15.80	17.90
Saten	11.06	11.06	13.16	15.80	15.80	17.90
📦	2	2	2	5	5	4



Kumru
Kod / SM-1501



	Oda	Yale	WC	Rozet Oda	Rozet Yale	Rozet WC
Alb.Saten	7.90	7.90	10.00	13.90	13.90	15.75
Mat Nikel	7.90	7.90	10.00	13.90	13.90	15.75
Saten	7.90	7.90	10.00	13.90	13.90	15.75
📦	2	2	2	5	5	4

Kumru Mandal
Kod / SM-1502



	T Mandal	L Mandal
Alb.Saten	3.90	5.10
Mat Nikel	3.90	5.10
Saten	3.90	5.10
📦	14	10

Bravo Mandal
Kod / SM-1503



	T Mandal	L Mandal
Alb.Saten	5.40	6.60
Mat Nikel	5.40	6.60
Saten	5.40	6.60
📦	14	10

Orkide Çekme

Kod / SM-1504



	20 cm	📦
Saten Krom	29.20	5
Alb.Saten	29.20	5
Saten	29.20	5

Lama Çekme

Kod / SM-1505



	20 cm	📦
Saten Krom	28.10	5
Alb.Saten	28.10	5
Saten	28.10	5

Lama Düz Çekme

Kod / SM-1506



	20 cm	📦
Saten Krom	28.10	5
Alb.Saten	28.10	5
Saten	28.10	5

Osmanlı Çekme

Kod / SM-1507



	Fiyat	📦
Nikel Saten	13.50	10
Alb.Saten	13.50	10
Saten	13.50	10
Sarı	13.50	10



Kuğu Çekme

Kod / SM-1508

	Fiyat	☐
Albirifin	6.75	10
Saten	6.75	10
Sarı	6.75	10



Hilal Çekme

Kod / SM-1509

	Fiyat	☐
Albirifin	8.64	10
Saten	8.64	10
Sarı	8.64	10



Atlas Çekme

Kod / SM-1510

	Fiyat	☐
Saten Krom	10.80	10
Alb.Saten	10.80	10
Saten	10.80	10
Sarı	10.80	10



Alm.Lale Çekme

Kod / SM-1511

	15 cm	20 cm
Albirifin	6.86	8.81
Saten	6.86	8.81
Sarı	6.86	8.81
☐	20	10



Paslanmaz Çekme

Kod / SM-1512

	Fiyat	📦
25 x 30	21.10	10
25 x 45	23.25	10
25 x 60	26.50	10
30 x 30	24.85	10
30 x 45	27.00	10
30 x 60	29.20	10



Kumru Çekme

Kod / SM-1513

	Fiyat	📦
Saten	4.32	25
Krom	4.32	25
Mat Krom	4.32	25
Sarı	4.32	25



Büyük Kıvrık Çekme

Kod / SM-1514

	Fiyat	📦
Saten	3.17	25
Krom	3.17	25
Mat Krom	3.17	25
Sarı	3.17	25



Küçük Kıvrık Çekme

Kod / SM-1515

	Fiyat	📦
Saten	1.83	50
Krom	1.83	50
Mat Krom	1.83	50
Sarı	1.83	50

Zamak Tak Tak

Kod / SM-1516



Saten	Krom	Sarı	
3.17	3.17	3.17	40

Damla Tak Tak

Kod / SM-1517



Saten	Krom	Albirifin	Sarı	
9.62	9.62	9.62	9.62	15

Kumru Tak Tak

Kod / SM-1518



Saten	Krom	Albirifin	Sarı	
4.43	4.43	4.43	4.43	25

Halka Tak Tak

Kod / SM-1519



Saten	Krom	Albirifin	Sarı	
9.35	9.35	9.35	9.35	20

Gamze Tak Tak

Kod / SM-1520



Saten	Krom	Albirifin	Sarı	
5.40	5.40	5.40	5.40	25

Mobaks Tak Tak

Kod / SM-1521



Saten	Krom	Albirifin	Sarı	
6.70	6.70	6.70	6.70	20

Alm. Kristal Tokmak

Kod / SM-1522



Saten	Sarı	Albirifin	📦
7.65	7.65	7.65	8

Ayarlı Sac Pergule

Kod / SM-1523



Sarı	📦
7.20	50

Zamak 8 Köşe Tokmak

Kod / SM-1524



Saten	Krom	M.Krom	📦
7.68	7.68	7.68	10

Kapalı Sac Pergule

Kod / SM-1525



	10 x 10	📦
Albirifin	7.20	25

Zamak Oluklu Tokmak

Kod / SM-1526



Saten	Krom	M.Krom	Sarı	📦
5.76	5.76	5.76	5.76	10

Kapalı Piring Pergule

Kod / SM-1527

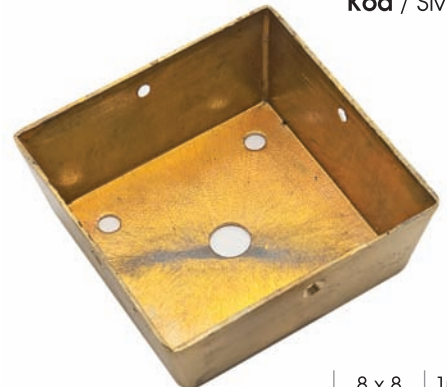

	8 x 8	10 x 10
Sarı	15.60	15.60
📦	10	10

Emniyet Kelepçesi

Kod / SM-1528

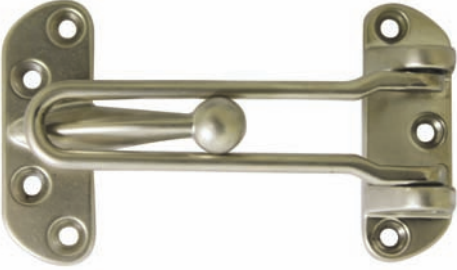

	Saten	Krom	Sarı	📦
	3.36	3.36	3.36	50

Mantar Tampon

Kod / SM-1529



	Saten	Krom	M.Krom	📦
5 cm	3.42	3.42	3.42	50

Zamak Yer Tamponu

Kod / SM-1530



	Saten	Krom	M.Krom	📦
3.5 cm	2.10	2.10	2.10	75
5 cm	2.30	2.30	2.30	50

Çelik Yer Tamponu (İçi Dolu)

Kod / SM-1531



	Sarı	Saten	Krom	Albirifin	📦
3.5 cm	4.11	4.11	4.11	4.11	75
5 cm	4.92	4.92	4.92	4.92	50

Sac Tampon

Kod / SM-1532



	Saten	Krom	Sarı	📦
	1.00	1.00	1.00	50

Pls.Kol Tamponu

Kod / SM-1533



	Fiyat	📦
	0.18	250

Alm. Cumbalı Mentеше

Kod / SM-1534



	Saten	Sarı	Naturel	📦
10 cm	2.20	2.20	2.20	400
12 cm	2.40	2.40	2.40	320

Alm. Okka Mentеше

Kod / SM-1535



	Saten	Sarı	Naturel	📦
10 cm	2.20	2.20	2.20	400
12 cm	2.40	2.40	2.40	320

Alm. German Mentеше

Kod / SM-1536



	Saten	Sarı	Naturel	📦
12 cm	1.80	1.80	1.80	400

Alm. Kelebek Mentеше

Kod / SM-1537



	Saten	Sarı	📦
10 cm	2.10	2.10	480

Çelik German Mentеше

Kod / SM-1538



	Saten	Sarı	
12 cm	2.60	2.60	160

Çelik Okka Mentеше

Kod / SM-1539

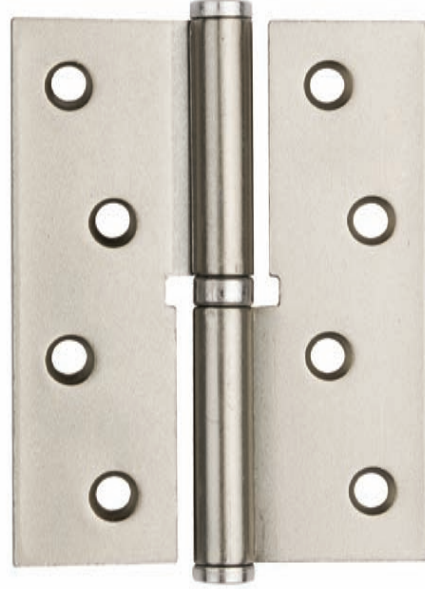

	Saten	Sarı	
10 cm	2.60	2.60	160

Çelik Cumbalı Mentеше

Kod / SM-1540



	Saten	Sarı	
10 cm	3.60	3.60	160

Çelik Kelebek Mentеше

Kod / SM-1541

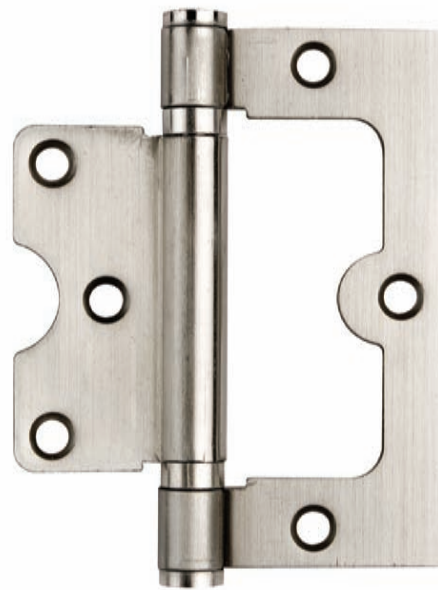

	Saten	Sarı	
10 cm	2.60	2.60	160

İtmeli Sürgü

Kod / SM-1542



	Sarı	Krom	Saten	📦
8 cm	2.89	3.92	3.92	100
10 cm	4.47	5.50	5.50	36
15 cm	5.07	6.11	6.11	20

Gömme Sürgü

Kod / SM-1543



	Sarı	Krom	Saten	📦
8 cm	3.51	4.55	4.55	100
10 cm	4.00	5.04	5.04	75
15 cm	4.84	5.87	5.87	50

Yassı Sürgü

Kod / SM-1544



	Sarı	Krom	Saten	📦
10 cm	8.27	9.30	9.30	30
15 cm	12.95	13.98	13.98	15

Otomatik Yassı Sürgü

Kod / SM-1545



	Sarı	Krom	Saten	📦
5 cm	5.39	6.42	6.42	36
8 cm	6.40	7.43	7.43	30
10 cm	9.60	10.63	10.63	20

Mavzer Sürgü

Kod / SM-1546



	Sarı	Krom	Saten	📦
5 cm	4.22	5.25	5.25	80
7 cm	4.92	5.95	5.95	60
10 cm	6.00	7.04	7.04	40

Lüks Mandallı Sürgü

Kod / SM-1547



	Sarı	Krom	Saten	📦
16 cm	7.25	7.25	7.25	30

Alm. Gömme Sürgü

Kod / SM-1548



	Sarı	Saten	📦
9 cm	3.12	3.12	40
12 cm	3.40	3.40	35

Dolap Sürgüsü

Kod / SM-1549



	Sarı	Krom	Saten	📦
6 cm	3.36	4.39	4.39	200
8 cm	4.22	5.25	5.25	100

Mini Sabit Mentеше

Kod / SM-1550



	Sarı	Saten	📦
2 cm	1.64	2.41	250
3 cm	2.03	2.80	150
4 cm	2.42	3.19	100

Dar Sabit Mentеше

Kod / SM-1551



	Sarı	Saten	📦
3 cm	2.42	3.19	150
4 cm	2.91	3.67	120
5 cm	2.92	3.69	100

Sabit Mentеше

Kod / SM-1552



	Sarı	Saten	📦
4 cm	2.92	3.69	100
5 cm	3.20	3.97	100
6 cm	3.59	4.36	80
8 cm	4.67	5.44	50

Geniş Sabit Mentеше

Kod / SM-1553



	Sarı	Saten	📦
6 cm	4.90	5.67	50
8 cm	5.70	6.46	50

Masa Mentешesi

Kod / SM-1554



	Sarı	Saten	☐
3 cm	5.15	5.92	40
4 cm	5.62	6.39	30

Sabit Masa Mentешesi

Kod / SM-1555



	Sarı	Saten	☐
30 x 76	5.62	6.39	50

Yuvarlak Mentешe

Kod / SM-1556



	Sarı	Saten	☐
30 x 30	2.11	2.88	150

Çiçek Mentешe

Kod / SM-1557



	Sarı	Saten	☐
2.5 cm	2.11	2.88	250
3.5 cm	2.73	3.50	200

Kelebek Mentешe

Kod / SM-1558



	Sarı	Saten	☐
5 cm	3.28	4.05	75

Pencere Kelebeđi ve Kaldıraç

Kod / SM-1559



	Sarı	Saten	☐
Kelebek	5.85	6.62	50
Kaldıraç	2.19	2.79	100

Okka Mentеше

Kod / SM-1560



	4 cm Düz	5 cm Düz	4 cm Memeli	5 cm Memeli
Sarı	2.81	3.12	3.12	3.44
Saten	3.59	3.90	3.90	4.22
📦	100	100	100	100

Cumbalı Mentеше

Kod / SM-1561



	4 cm Düz	5 cm Düz	4 cm Memeli	5 cm Memeli
Sarı	3.12	3.44	3.44	3.75
Saten	3.90	4.22	4.22	4.53
📦	60	60	60	60

Çelik Rozet

Kod / SM-1562



Krom	Albirifin	Sarı	Saten	📦
4.32	4.32	4.32	4.32	100

Zamak Numara

Kod / SM-1563



Sarı	Saten	📦
0.97	0.97	150

Piyon

Kod / SM-1564



	Sarı	Saten	Krom	📦
Ø 6 cm	1.52	1.76	1.76	150
Ø 8 cm	1.64	1.88	1.88	150

Dürbün Uzatması ve Pulu

Kod / SM-1565



	Sarı	Saten	📦
Uzatma	1.10	1.33	150
Pul	1.10	1.33	350

Alm. Dar Sabit Mentеше

Kod / SM-1566



	2,5 cm	4 cm	5 cm	6 cm	8 cm	10 cm
Sarı	1.20	1.20	1.32	1.32	1.56	1.74
Saten	1.20	1.20	1.32	1.32	1.56	1.74
📦	300	250	200	200	130	100

Alm. Okka Mentеше

Kod / SM-1567



	4 cm	5 cm
Sarı	1.32	1.32
Saten	1.32	1.32
📦	150	150

Alm. Sabit Mentеше

Kod / SM-1568



	2,5 cm	4 cm	5 cm	6 cm	8 cm
Sarı	1.20	1.32	1.32	1.32	1.56
Saten	1.20	1.32	1.32	1.32	1.56
📦	250	200	175	150	130

Alm. Cumbalı Mentеше

Kod / SM-1569



	4 cm	5 cm
Sarı	1.32	1.32
Saten	1.32	1.32
📦	150	150

Alm. Geniş Sabit Mentеше

Kod / SM-1570



	3 cm	4 cm	6 cm	8 cm
Sarı	1.32	1.56	1.80	2.04
Saten	1.32	1.56	1.80	2.04
📦	140	130	90	70

Alm. Mavzer Sürgü

Kod / SM-1571

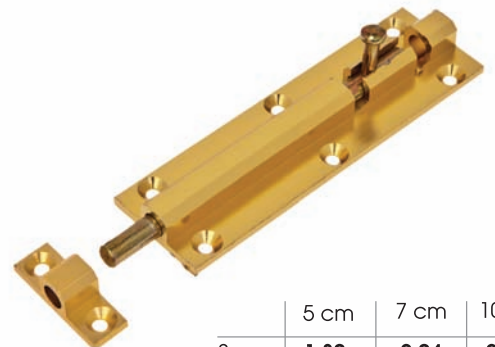

	5 cm	7 cm	10 cm
Sarı	1.80	2.04	2.40
Saten	1.80	2.04	2.40
📦	70	55	45

Alm. Oval U.Masa Mentешesi

Kod / SM-1572



	Sarı	Saten	
4 cm	1.80	1.80	95

Alm. Köşeli Kuyruklu Mentешe

Kod / SM-1573



	Sarı	Saten	
4 cm	1.80	1.80	110

Alm. Oval Masa Mentешesi

Kod / SM-1574



	Sarı	Saten	
3 cm	1.32	1.32	140
4 cm	1.80	1.80	110

Alm. Köşeli Uzun Masa Mentешesi

Kod / SM-1575



	Sarı	Saten	
4 cm	1.92	1.92	90

Alm. Oval Kuyruklu Mentешe

Kod / SM-1576



	Sarı	Saten	
3 cm	1.74	1.74	120

Alm.P.Kelebeđi ve Kaldıraç

Kod / SM-1577



	Sarı	Saten	
Kelebek	1.80	1.80	100
Kaldıraç	0.92	0.92	200

Pantolonluk 37 cm

Kod / SM-1578

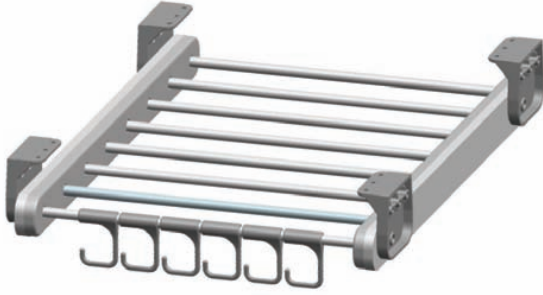

Derinlik	Genişlik	Fiyat	📦
37 cm	40 cm	20.52	13
37 cm	45 cm	21.55	12
37 cm	50 cm	23.10	11
37 cm	55 cm	24.63	12
37 cm	60 cm	26.68	12

Pantolonluk 47 cm

Kod / SM-1579

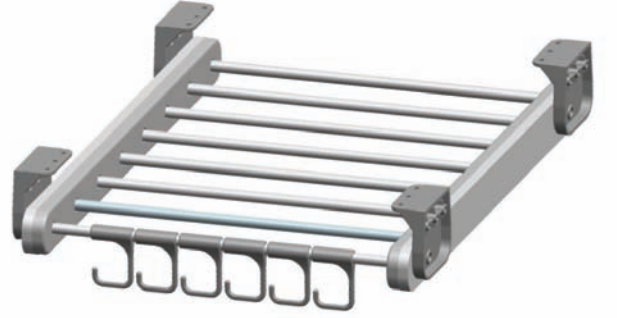

Derinlik	Genişlik	Fiyat	📦
47 cm	40 cm	25.14	11
47 cm	45 cm	26.42	10
47 cm	50 cm	27.71	9
47 cm	55 cm	29.50	10
47 cm	60 cm	31.81	10

Gardolap Asansörü

Kod / SM-1580



	📦
63.20	6

Evye Altı

Kod / SM-1581



	Alüminyum	📦		Alüminyum	📦
60 cm	15.94	10	100 cm	22.28	10
70 cm	17.04	10	110 cm	23.91	10
80 cm	18.68	10	120 cm	25.30	10
90 cm	20.33	10	Rulo	19.20	1 m

Kaşıklık
Kod / SM-1582



ölçü	Gri	📦	ölçü	Gri	📦
27 x 49	11.67	12	46 x 49	15.24	12
30 x 39	11.67	12	55 x 49	15.94	12
37 x 49	13.73	12	67 x 49	19.20	12
42 x 49	14.40	12	85 x 49	32.69	12

İthal Kaşıklık
Kod / SM-1583



ölçü	Gri	📦	ölçü	Gri	📦
30 x 49	11.86	12	55 x 49	18.96	12
37 x 49	16.32	12	67 x 49	22.00	12
42 x 49	17.21	12	75 x 49	31.06	12
46 x 49	17.81	12	85 x 49	34.64	12

Çöp Kovası
Kod / SM-1584



	1.Kalite	2.Kalite
Krom	30.00	23.20
📦	8	8

Raylı Çöp Kovası
Kod / SM-1585



	Tek Kova	Çift Kova
Krom	84.00	84.00
📦	6	6

Kapı Fitili

Kod / BT 001



	Pls.Renkler	Şeffaf	📦
1 mt.	0.47	0.47	100 mt.

Kapı Fitili

Kod / BT 002



	Pls.Renkler	Şeffaf	📦
1 mt.	0.47	0.47	100 mt.

Kapı Fitili

Kod / BT 003



	Pls.Renkler	Şeffaf	📦
1 mt.	0.47	0.47	100 mt.

Kapı Fitili

Kod / BT 010



	Pls.Renkler	Şeffaf	📦
1 mt.	0.47	0.47	100 mt.

Kapı Fitili

Kod / BT 012



	Pls.Renkler	Şeffaf	📦
1 mt.	0.47	0.47	100 mt.

Banyo Sızdırmazlık Profili

Kod / SM-1586



	Ebat	Şeffaf	📦
1 mt.	8 mm	0.94	300 mt.
1 mt.	14 mm	1.10	300 mt.

PVC U Profili

Kod / SM-1587



	Ebat	Pls.Renkler	📦
1 mt.	16 mm	0.90	300 mt.
1 mt.	18 mm	0.90	300 mt.

18 mm Lambiri Profili

Kod / SM-1588



	Pls.Renkler	📦
1 mt.	0.90	300 mt.

PVC İç Bükey Tezgah Süpürgeliği

Kod / SM-1589



	Düz Renkler	Kaplamalı	☐
1 mt.	2.50	3.00	88 m

Süpürgelik Kapağı

Kod / SM-1590



Pls.Renkler	☐
0.25	200 Ad.

İç Dönüş / Dış Dönüş

Kod / SM-1591



Pls.Renkler	☐
0.25	100 Ad.

H Profiller

Kod / SM-1592



	3.4 mm	4 mm	6 mm	8 mm	18 mm
Pls.Renkler	0.55	0.55	0.665	0.665	0.90
☐	300 mt	300 mt	300 mt	300 mt	150 mt

Çivili Raf Pimi

Kod / SM-1593



	Fiyat
Pls.Renkler	0.0098
☒	1000

Metal Başlı Raf Pimi

Kod / SM-1594



	5 mm
Pls.Renkler	0.030
☒	1000

Kristal Raf Pimi

Kod / SM-1595



	5 mm
Kristal	0.054
☒	1000

Pls.Dübelli Raf Pimi

Kod / SM-1596



	5 mm	6 mm
Pls.Renkler	0.010	0.010
☒	1000	1000

Metal Raf Pimi

Kod / SM-1597



	5 mm
Çinko	0.025
☒	1000

5 mm Metal Raf Pimi

Kod / SM-1598



	5 mm
Nikel	0.087
☒	1000

Metal Vidalı Raf Pimi

Kod / SM-1599



	6.5 x 20
Nikel	0.27
☒	1000

Metal Vidalı Contalı Raf Pimi

Kod / SM-1600



	6.5 x 20
Nikel	0.30
☒	1000

Metal Contalı Raf Pimi

Kod / SM-1601



	6 mm
Nikel	0.30
	1.000

Metal Çift Contalı Raf Pimi

Kod / SM-1602



	5 mm
Nikel	0.27
	1.000

Metal Çivili Contalı Raf Pimi

Kod / SM-1603



	Fiyat
Nikel	0.22
	1.000

Metal Vidalı Pimli Raf Pimi

Kod / SM-1604



	5 mm
Nikel	0.17
	1.000

Pimli Metal Raf Pimi

Kod / SM-1605



	5 mm
Nikel	0.083
	1.000

Düz Metal Raf Pimi

Kod / SM-1606



	5 mm
Nikel	0.083
	1.000

Vantuzlu Raf Pimi Geniş

Kod / SM-1607



	5 mm
Nikel	0.141
	1.000

Vantuzlu Raf Pimi Dar

Kod / SM-1608



	5 mm
Nikel	0.141
	1.000

Tapalı Raf Pimi

Kod / SM-1609



	12 x 22.5
Krom	1.08
📦	200

Contalı Raf Pimi

Kod / SM-1610



	12 x 18	14 x 20	10 x 15
Krom	0.61	0.83	0.53
📦	200	200	200

Rafix

Kod / SM-1611



	20 mm
Pls.Renkler	0.098
📦	500

Gizli Raf Tutucu

Kod / SM-1612



	10 cm	14 cm
Çinko	2.70	3.15
📦	60 Tk.	50 Tk.

Dikey ve Yatay Fix

Kod / SM-1613



	15 x 12	📦
Dikey	0.603	500
Yatay	0.612	500

Köşe Koruyucu

Kod / SM-1614



	Fiyat
Siyah	0.040
📦	3000

Beşik Sallama Aparatı

Kod / SM-1615



	Fiyat
Kısa	1.90
Uzun	1.90
📦	100

Beşik Mekanizması

Kod / SM-1616



	Fiyat
Krom	14.50
📦	20

Eğri Metal T Çektirme

Kod / SM-1617



	Fiyat
Çinko	0.495
Janjan	0.495
Nikel	0.656
☐	100

Metal Açılı Kelebek T Bağlantı

Kod / SM-1618



	Fiyat
Çinko	0.41
Janjan	0.41
☐	100

Metal Açılı T Bağlantı

Kod / SM-1619



	Fiyat
Çinko	0.38
Janjan	0.38
☐	100

Şeffaf Açılı T Bağlantı

Kod / SM-1620



	Fiyat
Şeffaf	0.34
☐	100

Büyük Metal T Çektirme

Kod / SM-1621



	Fiyat
Çinko	0.495
Janjan	0.495
Nikel	0.656
☐	100

Metal T Çektirme

Kod / SM-1622



	Fiyat
Çinko	0.38
Janjan	0.38
Nikel	0.518
☐	100

Metal T Bağlantı

Kod / SM-1623



	Fiyat
Çinko	0.35
Janjan	0.35
☐	100

Plastik T Bağlantı

Kod / SM-1624



	Fiyat
Pls.Renkler	0.195
☐	100

Daset Askı Elemanı



Kod	Ürün	Fiyat	📦
SM-1625	Daset	1.00	300
SM-1626	Kanca	0.30	300
SM-1627	Sac	0.50	300

Askı Elemanı



Kod	Ölçü	Renk	Fiyat	📦
SM-1628	1.2 mm	Pls.Renkler	0.30	250
SM-1629	1.5 mm	Pls.Renkler	0.35	250

Pls. Kapaklı Gönye

Kod / SM-1630



	35 x 40 x 40
Pls.Renkler	0.72
📦	200

Pls. L Bağlantı

Kod / SM-1631



	Fiyat
Pls.Renkler	0.046
📦	250

Pls. Kapaklı Köşe Bağlantı

Kod / SM-1632



	Fiyat
Pls.Renkler	0.054
📦	250

Pls. Kapaklı Köşe Bağlantı Tekli

Kod / SM-1633



	Fiyat
Pls.Renkler	0.046
📦	250

Köprü Bağlantı

Kod / SM-1634



	Fiyat
Pls.Renkler	0.34
📦	500

Blum Bağlantı

Kod / SM-1635



Özellik	Renk	Fiyat	📦
Açık Taban	Pls.Renkler	0.29	1000
Kap.Taban	Pls.Renkler	0.32	1000

Pls. Tırnaklı Çektirme

Kod / SM-1636



	Fiyat	
Plastik Renkler	0.27	
📦	100	

Metal Tırnaklı Çektirme

Kod / SM-1637



	Fiyat	
Janjan	0.29	
📦	100	

Gardrop Bağlantısı

Kod / SM-1638



	Fiyat	
Janjan	0.48	
📦	50	

Arkalık Çektirme

Kod / SM-1639

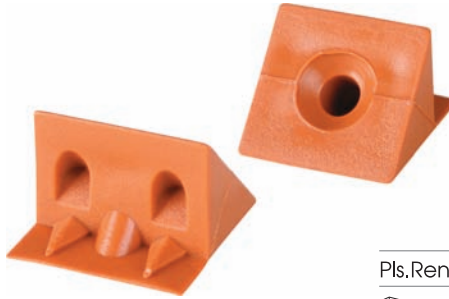

	Fiyat	
Pls.Renkler	0.013	
📦	2000	

L Köşe Gönye

Kod / SM-1640



Ölçü	Fiyat	📦	Ölçü	Fiyat	📦
25 x 25	0.13	200	45 x 45	0.19	200
35 x 35	0.17	200	55 x 55	0.22	200

Metal Gönye Oval

Kod / SM-1641



	23 x 30 x 30	
Çinko	0.22	
📦	200	

Metal L Gönye

Kod / SM-1642



Ölçü	Fiyat	📦
30 x 25 x 25	0.26	200
30 x 35 x 35	0.32	200
30 x 45 x 45	0.37	200

Banyo Dolap Askı Elemanı

Kod / SM-1643



	Fiyat	
Çinko	4.76	
📦	100	

Bilyalı Çıt Çıt

Kod / SM-1644

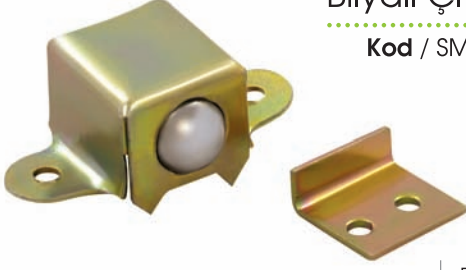

	Fiyat
Janjan	0.32
📦	100

Pls. Çıt Çıt

Kod / SM-1645



	Fiyat
Pls.Renkler	0.074
📦	250

H Kırangiçlar

Kod / SM-1646



	Fiyat
Pls.Renkler	0.009
📦	1000

Tombul Kırangiç

Kod / SM-1647



	Fiyat
Pls.Renkler	0.009
📦	1000

Tırnaklı Karyola Demiri

Kod / SM-1648



	Fiyat
Janjan	2.64
📦	10

Dübelli Karyola Demiri

Kod / SM-1649

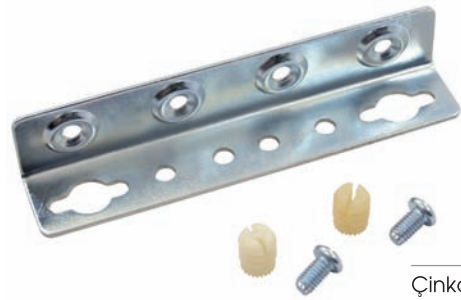

	Fiyat
Çinko	2.88
📦	10

4 Delikli Karyola Demiri

Kod / SM-1650

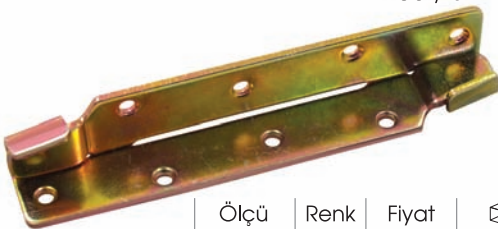

Ölçü	Renk	Fiyat	📦
9 cm	Janjan	2.88	10
12.5 cm	Janjan	3.60	10
15 cm	Janjan	4.80	10

Mil Menteşe

Kod / SM-1651

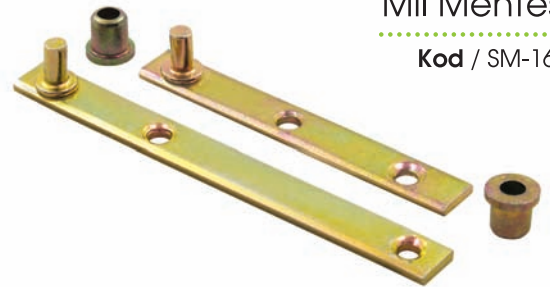

Ölçü	Renk	Fiyat	📦
6'lık	Janjan	9.60	2 Dz.
8'lik	Janjan	10.80	2 Dz.

Ayarlı Cam Etejeri

Kod / SM-1652



	Fiyat
Krom	2.27
Saten	2.38
M.Krom	2.38
📦	75

Ayarlı Cam Tutucu

Kod / SM-1653



	14 x 15
Krom	1.33
📦	200

Oval Cam Etejeri

Kod / SM-1654



Özellik	Krom	Saten	M.Krom	📦
Plastik Vidalı	1.38	1.41	1.41	100
Metal Vidalı	1.46	1.48	1.48	100

Mini Oval Cam Etejeri

Kod / SM-1655



Özellik	Krom	Saten	M.Krom	📦
Plastik Vidalı	0.78	0.80	0.80	200
Metal Vidalı	0.86	0.89	0.89	200

Metal Cam Raf Tutucu Düz

Kod / SM-1656



Özellik	Krom	Nikel	📦
Plastik Vidalı	0.36	0.31	500
Metal Vidalı	0.44	0.38	500

Metal Cam Raf Tutucu Pimli

Kod / SM-1657



Özellik	Krom	Nikel	📦
Plastik Vidalı	0.37	0.33	500
Metal Vidalı	0.45	0.40	500

U Cam Etejeri

Kod / SM-1658



Özellik	Krom	Saten	M.Krom	📦
Plastik Vidalı	1.41	1.43	1.43	100
Metal Vidalı	1.48	1.51	1.51	100

Tabela Vidası

Kod / SM-1659



	Krom	📦
13 x 20	1.59	200
17 x 10	1.59	200
17 x 20	1.85	100
17 x 27	1.98	100
17 x 40	2.11	100
25 x 30	3.15	100

Eko Yuvarlak Boru Babası

Kod / SM-1660



Özellik	Krom	📦
Açık	1.00	100
Kapalı	1.10	100

Lüks Yuvarlak Boru Babası

Kod / SM-1661



Özellik	Krom	📦
Açık	1.73	100
Kapalı	1.73	100

Eko Oval Boru Babası

Kod / SM-1662



Özellik	Krom	📦
Açık	0.90	100
Kapalı	1.00	100

Uzun Askı Flanş

Kod / SM-1663



	Krom
Çinko	0.42
Nikel	0.551
📦	200

Eko Oval Flanş

Kod / SM-1664



Özellik	Çinko	Nikel	📦
Düz	0.184	0.242	500
Pimli	0.21	0.27	400

Oval Flanş

Kod / SM-1665



Özellik	Çinko	Nikel	📦
Düz	0.23	0.30	500
Pimli	0.25	0.32	400

2 Delikli Flanş

Kod / SM-1666



	Fiyat
Çinko	0.11
📦	200

4 Delikli Flanş

Kod / SM-1667



	Fiyat
Çinko	0.22
📦	100

Metal Kapaklı Flanş

Kod / SM-1668



	Fiyat
Pls.Renkler	0.72
	100

Yuvarlak Flanş

Kod / SM-1669



	Krom	
Vidalı	0.59	150
Vidasız	0.54	150

T Boru Flanşı

Kod / SM-1670



	Fiyat
Krom	3.08
	40

L Boru Flanşı

Kod / SM-1671



	Fiyat
Krom	2.88
	40

Askı Borusu

Kod / SM-1672



Ölçü	Özellik	Krom	
1 mt	Yuvarlak	3.40	30 m
1 mt	Oval	3.70	30 m

Mutfak Askı Borusu

Kod / SM-1673



	40 cm	60 cm	80 cm	100 cm	120 cm
Krom	2.86	3.78	5.07	6.04	7.33
	20	20	20	20	20

Boru Bağlantısı

Kod / SM-1674



	Fiyat
Krom	2.70
	100

Boru Tapası

Kod / SM-1675



	Fiyat
Krom	0.62
	100

S Kanca

Kod / SM-1676



	Krom	📦
Açık	0.72	200
Kapalı	0.72	200

9 Kanca

Kod / SM-1677



	Fiyat	
Krom	0.72	
📦	200	

Vida Kapama

Kod / SM-1678

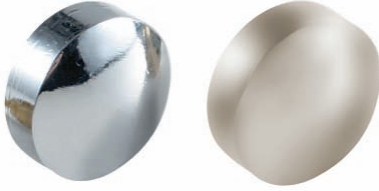

	13 mm	15 mm	20 mm	25 mm
Krom	0.20	0.22	0.28	0.50
Saten	0.20	0.22	0.28	0.50
📦	2000	2000	1000	500

Boy Mentşe

Kod / SM-1679

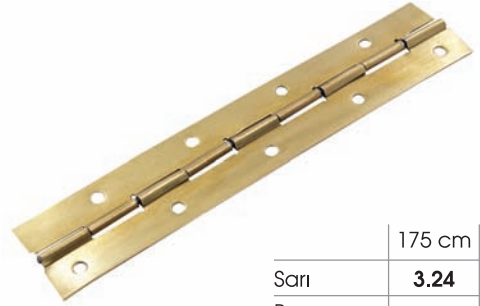

	175 cm	📦
Sarı	3.24	50
Beyaz	3.00	50

Metal TV Altlığı

Kod / SM-1680



	Fiyat
Çinko	10.48
📦	12

Plastik Kavalye

Kod / SM-1681



	8 x 30
Siyah	0.011
Plastik Renkler	0.013
📦	2500

Kablo Kanalı

Kod / SM-1682



	Fiyat
Plastik Renkler	0.32
📦	60

Ayakkabılık

Kod / SM-1683



	Fiyat
Plastik Renkler	2.90
📦	50

Baza Pabucu

Kod / SM-1684



Pls.Renkler	Fiyat
0.019	
500	

Çivili Poligrit

Kod / SM-1685



Pls.Renkler	Fiyat
0.028	
1000	

Yatay CD Aparatı

Kod / SM-1686



	Fiyat
Siyah	1.62
Gri	1.89
100	

Dikey CD Aparatı

Kod / SM-1687



	Fiyat
Siyah	1.89
Gri	2.16
100	

Yuvarlak Tas Kulp

Kod / SM-1688



Krom	M.Krom	Saten	Pls.Renkler	100
0.81	0.56	0.56	0.36	

Oval Tas Kulp

Kod / SM-1689



Krom	M.Krom	Saten	Pls.Renkler	25
1.59	0.97	0.97	0.69	

Tamir Macunu

Kod / SM-1690



	Fiyat
Plastik Renkler	1.10
30	

Bingo ve Vazo Sacı



Kod	Ürün	Fiyat	200
SM-1691	B.Sacı	0.11	
SM-1692	V.Sacı	0.22	

Pls. Dubelli Minifix



Kod	Ölçü	Çinko	Nikel	📦
SM-1693	15x12	0.165	0.188	1000
SM-1694	15x13.3	0.165	0.188	1000

Metal Dubelli Minifix



Kod	Ölçü	Çinko	Nikel	📦
SM-1695	15x12	0.212	0.238	1000
SM-1696	15x13.3	0.212	0.238	1000

Minifix Gövde



Kod	Ölçü	Çinko	Nikel	📦
SM-1697	15x12	0.085	0.11	1000
SM-1698	15x13.3	0.085	0.11	1000

Minifix Mili



Kod	Özellik	Ölçü	Fiyat	📦
SM-1699	M.6 Diş	7x43	0.063	1000
SM-1700	Sunta Diş	7x43	0.063	1000

Kendinden Dübelli Minifix



Kod	Ölçü	Çinko	Nikel	📦
SM-1701	15x12	0.184	0.206	1000
SM-1702	15x13.3	0.184	0.206	1000

Kendinden Dübelli Minifix Mili



Kod	Ölçü	Fiyat	📦
SM-1703	8x43	0.11	1000
SM-1704	10x43	0.11	1000

Hareketli Ara Mil

Kod / SM-1705



Çinko	Fiyat
0.87	
📦	250

Kavalye Çivisi

Kod / SM-1706



Zamak	38 mm
0.039	
📦	1000

Montebent

Kod / SM-1707



	40 mm	60 mm	80 mm	Somun
Çinko	0.134	0.173	0.212	0.072
📦	500	500	500	1000

Mini Montebent

Kod / SM-1708



	Fiyat
40 mm	0.162
📦	1000

Kabin Vidası



Kod	Özellik	Ölçü	Fiyat	📦
SM-1709	Alyan	6.3x50	0.058	1000
SM-1710	Yıldız	6.3x50	0.058	1000

Alyan Anahtar

Kod / SM-1711



	Fiyat
4 mm	0.10
📦	1000

Kulp Vidası

Kod / SM-1712



	Fiyat	📦
M 4 x 22	0.020	14.000
M 4 x 25	0.021	10.000
M 4 x 30	0.025	9.000
M 4 x 35	0.030	8.000
M 4 x 40	0.032	7.000

Ray Vidası



Kod	Ölçü	Fiyat	📦
SM-1713	6.3x9.5	0.024	1000
SM-1714	6.3x13	0.026	1000

Çakma Somun

Kod / SM-1715



	M 6	M 8	M 10	5 / 16
Çinko	0.065	0.091	0.173	0.091
📦	1000	1000	500	500

Kaynak Somun

Kod / SM-1716



	M 6	M 6 Kısa	M 8	5 / 16
Çelik	0.065	0.065	0.091	0.091
📦	1000	1000	1000	1000

M 6 Silindir Çektirme Vidası

Kod / SM-1717



	6 x 30	6 x 40	6 x 50	6 x 60	6 x 70	6 x 80
Çinko	0.089	0.102	0.121	0.147	0.167	0.188
Nikel	0.115	0.139	0.169	0.197	0.225	0.266
📦	1000	1000	1000	1000	1000	1000

M 6 Silindir Somun

Kod / SM-1718



	10 x 20	10 x 14	10 x 13
Zamak	0.216	0.104	0.104
📦	1000	1000	1000

M 6 Alyan Somun

Kod / SM-1719



	Ölçü	Çinko	Nikel	📦
4 Alyan	7.45 x 12	0.184	0.199	1000
5 Alyan	7.42 x 20	0.199	0.223	1000

M 6 Kör Somun

Kod / SM-1720



	8.8 x 20
Çinko	0.195
Nikel	0.223
📦	1000

M 6 Metal Dübel

Kod / SM-1721



	8 x 10	8 x 13
Zamak	0.067	0.067
📦	1000	1000

M 8 Metal Dübel

Kod / SM-1722



	10 x 12	10 x 15	10 x 20
Zamak	0.096	0.096	0.115
📦	1000	1000	1000

M 10 Metal Dübel

Kod / SM-1723



	13 x 17
Zamak	0.154
📦	500

Sandık Kulpu

Kod / SM-1724



	Fiyat
Janjan	16.56
📦	1 Dz.

Küçük Bingo

Kod / SM-1725



	Fiyat	
Plastik Renkler	0.167	
	400	

Büyük Bingo

Kod / SM-1726



	Fiyat	
Plastik Renkler	0.216	
	200	

Oynar Başlı Bingo

Kod / SM-1727



	Fiyat	
M 8 Plastik	0.61	
M 10 Plastik	0.61	
	500	

Oynar Başlı Bingo

Kod / SM-1728



	Fiyat	
M 8 Paslanmaz	0.93	
M 10 Paslanmaz	0.93	
	500	

Plastik Dübel

Kod / SM-1729



	Fiyat	
6 mm	0.010	1000
7 mm	0.011	1000
8 mm	0.013	1000
10 mm	0.023	1000
12 mm	0.051	500
14 mm	0.105	250

Roket Dübel

Kod / SM-1730



	Fiyat	
8 mm	0.044	500
10 mm	0.062	500

Tuğla Boşluk Dübeli

Kod / SM-1731



	Fiyat	
8 mm	0.040	500
10 mm	0.058	500

Alçıpan Dübeli

Kod / SM-1732



Ölçü	Boy	Fiyat	
9 mm	28.5 mm	0.065	500
9 mm	33.5 mm	0.070	500

OKYANUS

Furniture Equipment

Yapışkan Tapalar

Kod / SM-1733

 KAYIN	 ARMUT	 AKÇA AĞAÇ	 VENGE	 MAUN
 KİRAZ	 AÇIK KİRAZ	 MEŞE	 NATUREL MEŞE	 EĞRIDİR MEŞE
 HUŞ	 DOĞAL HUŞ	 KOYU CEVİZ	 YENİ CEVİZ	 İTALYAN CEVİZ
 TİK	 KOYU ÇAM	 ZEYTİN	 ABANOZ	 KOYU ZEBRANO
 BANU	 BEYAZ AKÇAAĞAÇ	 CAPPUCINO	 BAZ ARMUT	 BAZ KAYIN
 BEYAZ	 YENİ BEYAZ	 KREM	 BEJ	 FÜME
 GRI	 METALİK GRI	 SARI	 PORTAKAL	 SU YEŞİLİ
 LİLA	 MAVİ	 PEMBE	 KIRMIZI	 BORDO
 SİYAH				

Fiyat	
0.31	50 Plk



Dekoratif Bordür

Kod / SM-1734

Ebat	Fiyat	
50 x 215	36.65	50 Plk

Renkler

M.Gri - Desenli M.Gri - Fırçalı Metal Akçaağaç - Koyu Ceviz- Venge - Huş Portakal - Kırmızı - Siyah

Yapışkan Tapalar

Kod / SM-1735



Parlak Renkler



Fiyat	
0.476	50 Pk



Yapışkanlı Keçeler

Kod / SM-1736

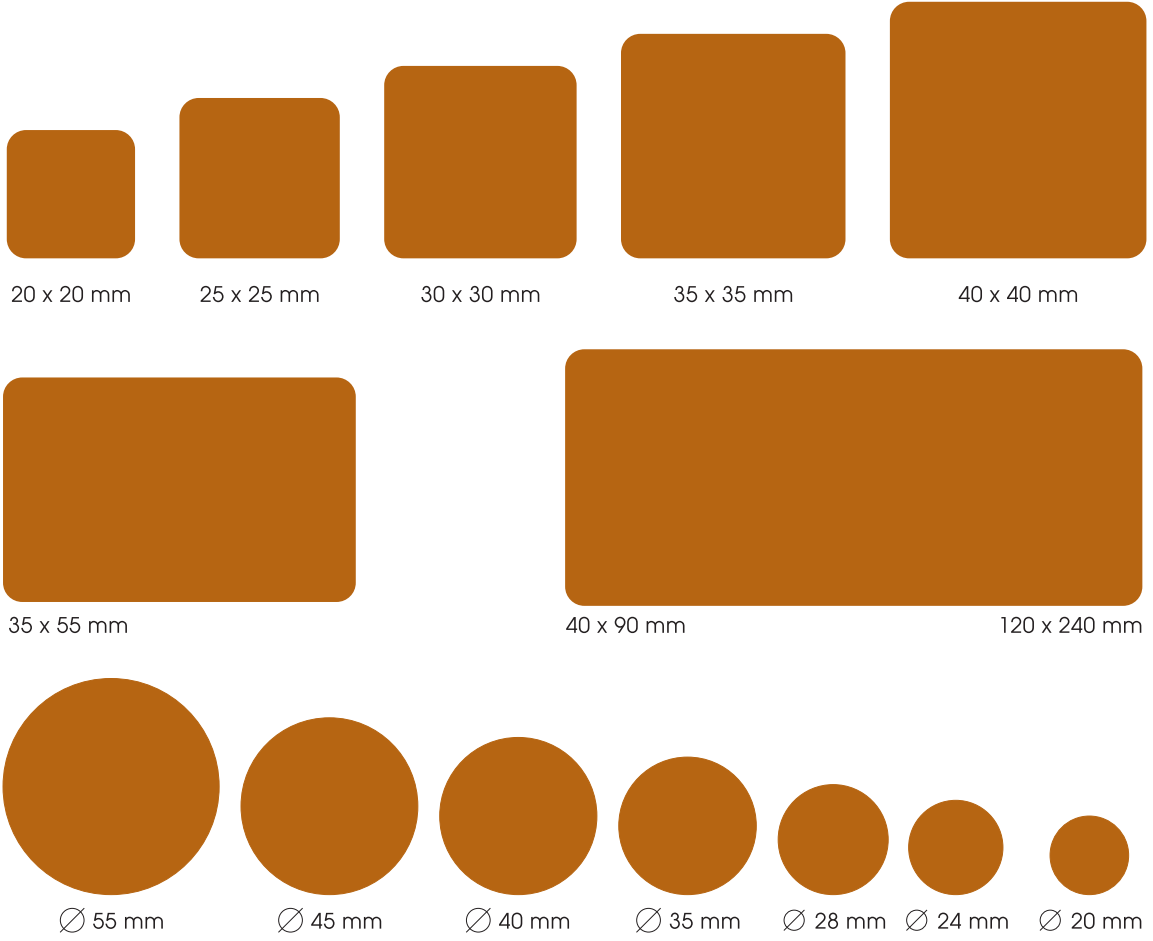

20 x 20 mm

25 x 25 mm

30 x 30 mm

35 x 35 mm

40 x 40 mm

35 x 55 mm

40 x 90 mm

120 x 240 mm

Ø 55 mm

Ø 45 mm

Ø 40 mm

Ø 35 mm

Ø 28 mm

Ø 24 mm

Ø 20 mm

Fiyat	
0.90	50 Pk

Silikon Bazlı Ses Stoperi

Kod / SM-1737



Fiyat	
1.50	100 Pk



Fiyat	
1.40	100 Pk

Lale Makas



Kod	Renk	Fiyat	📦
799100	Nikel	6.75	100

Mini Lale Makas



Kod	Renk	Fiyat	📦
850000	Nikel	4.36	100

Mega Lale Makas



Kod	820000	820001	820002	820003	820004	820005
Renk	Beyaz	Kahve	Gri	Şeffaf	Krem	Krom
Fiyat	4.62	4.62	4.99	4.62	4.62	5.78
📦	200	200	200	200	200	200

Mega Metal Makas



Kod	830000	830001	830002	830003
Renk	ZN	Nikel	Saten	B.Oksit
Fiyat	4.10	4.73	5.46	4.73
📦	100	100	100	100

Gonca Makas



Kod	Renk	Fiyat	📦
825000	Nikel	5.15	150

Mini Metal Makas



Kod	851000	851001	851002	851003
Renk	ZN	Nikel	Saten	B.Oksit
Fiyat	3.26	3.64	4.03	3.64
📦	100	100	100	100

Kırılan Kalkar Kapak



	Kod	Renk	Fiyat	📦
Sol	890000	Nikel	7.61	100
Sağ	890001	Nikel	7.61	100

Kırılan Düşer Kapak



	Kod	Renk	Fiyat	📦
Sol	891000	Nikel	7.61	100
Sağ	891001	Nikel	7.61	100

Sessiz Kalkar Kapak Mekanizması



Kod	Ölçü	Renk	Fiyat	📦
715000	15 cm	Nikel	1.52	300
720000	20 cm	Nikel	1.63	300
725000	25 cm	Nikel	1.73	300
730000	30 cm	Nikel	1.84	300

Teleskopik K.Kapak Mekanizması

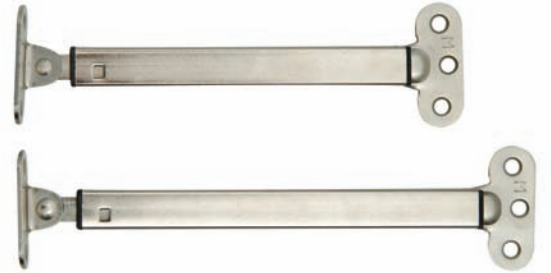

Kod	Ölçü	Renk	Fiyat	📦
920000	20 cm	Nikel	3.94	300
925000	25 cm	Nikel	4.20	300

Kilitli Bar Makası



Kod	Renk	Fiyat	📦
510000	Beyaz	1.58	500
520000	Kahve	1.58	500
530000	Meşe	1.58	500

Düz Bar Makası



Kod	Renk	Fiyat	📦
610000	Beyaz	1.31	500
620000	Kahve	1.31	500
630000	Meşe	1.31	500

Dikey K.Kapak Mekanizması



Kod	Kapak Aralığı	Fiyat	📦
870000	640-900	79.00	10
871000	480-690	79.00	10

Yaylı Ayarlı K.Kapak Mekanizması



Kod	Renk	Fiyat	📦
893000	Nikel	8.93	50

Yaylı Amortisör



Kod	Ölçü	Renk	Fiyat	📦
793000	15 cm	Nikel	3.83	250
794000	20 cm	Nikel	4.15	250
795000	25 cm	Nikel	4.46	250

Gazlı Amortisör



Kod	Ölçü	Renk	Fiyat	📦
797000	20 cm	Nikel	7.61	200
798000	25 cm	Nikel	8.14	200

Plastik Konsol 12 Cm



Kod	345100	345200	345300	345400	345500
Renk	Beyaz	Kahve	Meşe	Siyah	Gri
Fiyat	1.37	1.37	1.37	1.37	1.37
📦	100	100	100	100	100

Katlanır Konsol Renkli



Renkler : Sarı, Kırmızı, Lacivert
Pembe, Yeşil, Gri

Kod	Ölçü	Fiyat	Eko Fiyat	📦
320400	20 cm	12.00	10.35	40
330400	30 cm	15.00	13.65	30
340400	40 cm	20.20	18.65	20

Ayarlı Açılı Konsol 30 cm



Kod	Renk	Fiyat	Eko Fiyat	📦
200000	ZN	21.50	18.90	10
210000	Beyaz	23.50	21.00	10
220000	Kahve	23.50	21.00	10

Katlanır Konsol 20 cm



Kod	Renk	Fiyat	Eko Fiyat	📦
320000	ZN	8.40	7.20	40
320100	Beyaz	9.80	8.70	40
320200	Kahve	9.80	8.70	40

Ayarlı Açılı Konsol 40 cm



Kod	Renk	Fiyat	Eko Fiyat	📦
100000	ZN	31.00	28.00	10
110000	Beyaz	33.00	30.00	10
120000	Kahve	33.00	30.00	10

Katlanır Konsol 30 cm



Kod	Renk	Fiyat	Eko Fiyat	📦
330000	ZN	9.80	8.50	30
330100	Beyaz	11.70	10.36	30
330200	Kahve	11.70	10.36	30

Ayarlı Açılı Konsol 50 cm



Kod	Renk	Fiyat	Eko Fiyat	📦
150000	ZN	37.00	34.00	10
160000	Beyaz	39.00	36.00	10
170000	Kahve	39.00	36.00	10

Katlanır Konsol 40 cm



Kod	Renk	Fiyat	Eko Fiyat	📦
340000	ZN	13.80	12.15	20
340100	Beyaz	15.77	14.25	20
340200	Kahve	15.77	14.25	20

İtici Mıknatıs Tekli



Kod	Renk	Fiyat	Eko Fiyat	📦
761000	Siyah	0.83	100	
762000	Beyaz	0.83	100	
765000	Gri	0.83	100	

İtici Mıknatıs Çiftli

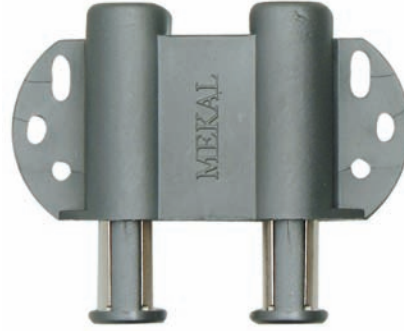

Kod	Renk	Fiyat	Eko Fiyat	📦
771000	Siyah	1.66	50	
772000	Beyaz	1.66	50	
775000	Gri	1.66	50	

Master Cam Mentşe



Kod	Renk	Fiyat	Eko Fiyat	📦
751000	Siyah	1.05	0.91	100
752000	Nikel	1.10	1.00	100
753000	Gri	1.10	1.00	100
755000	Saten	1.60	1.44	100

Mıknatıs Karşılık Saclar



Kod	Renk	Fiyat	Eko Fiyat	📦
781000	Siyah	0.17	100	
782000	Nikel	0.18	100	
783000	Gri	0.18	100	
785000	Saten	0.26	100	

Master Tekli Set



Kod	Renk	Fiyat	Eko Fiyat	📦
791000	Siyah	2.05	1.91	100
791100	Gri	2.11	2.01	100

Master Çiftli Set

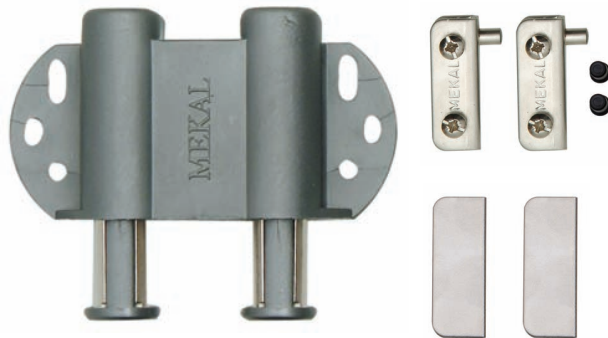

Kod	Renk	Fiyat	Eko Fiyat	📦
792000	Siyah	4.10	3.82	50
792100	Gri	4.22	3.80	50

Tas Mentеше Düz

Kod / SM-1738



Fiyat	📦
	250

Frenli Mentеше Düz

Kod / SM-1739



Fiyat	📦
	100

Tas Mentеше Y.Deve Boynu

Kod / SM-1740



Fiyat	📦
	250

Frenli Mentеше Yarım Deve

Kod / SM-1741



Fiyat	📦
	100

Tas Mentеше S.Deve Boynu

Kod / SM-1742



Fiyat	📦
	250

Frenli Mentеше Süper Deve

Kod / SM-1743



Fiyat	📦
	100



45° Derece Mentеше

Kod / SM-1744

Fiyat	
	200



30° Derece Hidrolik Mentеше

Kod / SM-1745

Fiyat	
	100



90° Derece Mentеше

Kod / SM-1746

Fiyat	
	200



45° Derece Hidrolik Mentеше

Kod / SM-1747

Fiyat	
	100



135° Derece Mentеше

Kod / SM-1748

Fiyat	
	200



90° Derece Hidrolik Mentеше

Kod / SM-1749

Fiyat	
	100



165° Derece Mentеше

Kod / SM-1750

Fiyat	
	100

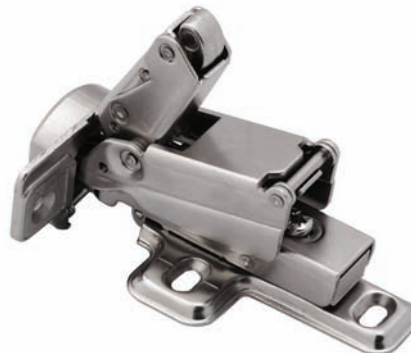

165° Derece Hidrolik Mentеше

Kod / SM-1751

Fiyat	
	100

Klasik Çekmece Rayı

Kod / SM-1752



Ölçü	Fiyat	📦
30 cm		25
35 cm		25
40 cm		25
45 cm		25
50 cm		25
55 cm		25
60 cm		25

17 mm Tek Açılım İnce Bilyalı Ray

Kod / SM-1753



Ölçü	Fiyat	📦
17 x 310 mm		50
17 x 342 mm		50
17 x 406 mm		50
17 x 438 mm		50

30 mm Çift Açılım Teleskopik Ray

Kod / SM-1754



Ölçü	Fiyat	📦
30 x 350 mm		30
30 x 400 mm		30
30 x 450 mm		30
30 x 500 mm		30

32 mm Çift Açılım Teleskopik Ray

Kod / SM-1755



Ölçü	Fiyat	📦
32 x 250 mm		20
32 x 300 mm		20
32 x 350 mm		20
32 x 400 mm		20
32 x 450 mm		20
32 x 500 mm		20

35 mm Çift Açılım Teleskopik Ray

Kod / SM-1756



Ölçü	Fiyat	📦
35 x 300 mm		20
35 x 350 mm		20
35 x 400 mm		20
35 x 450 mm		20
35 x 500 mm		20
35 x 550 mm		20

45 mm Çift Açılım Teleskopik Ray

Kod / SM-1757



Ölçü	Fiyat	📦
45 x 250 mm		15
45 x 300 mm		15
45 x 350 mm		15
45 x 400 mm		15
45 x 450 mm		15
45 x 500 mm		15
45 x 550 mm		15

45 mm Frenli Teleskopik Ray

Kod / SM-1758



Ölçü	Fiyat	📦
45 x 300 mm		15
45 x 350 mm		15
45 x 400 mm		15
45 x 450 mm		15
45 x 500 mm		15
45 x 550 mm		15

Gazlı Piston

Kod / SM-1759



Ölçü	60 N	80 N	100 N	120 N
Fiyat				
📦	100	100	100	100

Lale Makas

Kod / SM-1760



Fiyat	📦
	100

Otel Tipi Kilit

Kod / SM-1761



Fiyat	📦
	30

Zimba Teli

Kod / SM-1762



Ölçü	8	10	12	14
Fiyat				
📦	30	30	30	30

Çekmece Kilidi Kare

Kod / SM-1763



Fiyat	📦
	240

Çekmece Kilidi Oval

Kod / SM-1764



Fiyat	📦
	240

Streç Film

Kod / SM-1765



Fiyat	
	6

Extra Kilit

Kod / SM-1766



	Oda	WC	
35 mm			40
40 mm			40

FEL Şarjlı Matkap

Kod / SM-1767



14.4V	
	5

FEL Kırıcı-Delici Matkap

Kod / SM-1768



800W	
	5

FEL Döşeme Tabancası

Kod / SM-1769



6-16 mm	
	10

FEL Çivi Tabancası

Kod / SM-1770



10-32 mm	
	10

ÖLÇÜ	ÇİNKO	SARI	SİYAH	FİYAT TL/1000	KOLİ	KUTU	FİYAT TL/KUTU
2,5 x 16 mm	●	●	●	6.90	30,000 Ad.	1,000 Ad.	6.90
2,5 x 25 mm	●	●		9.90	20,000 Ad.	1,000 Ad.	9.90
3,0 x 13 mm	●	●		7.36	30,000 Ad.	1,000 Ad.	7.36
3,0 x 15 mm	●			7.60	30,000 Ad.	1,000 Ad.	7.60
3,0 x 16 mm	●	●		7.60	30,000 Ad.	1,000 Ad.	7.60
3,0 x 18 mm	●			7.75	30,000 Ad.	1,000 Ad.	7.75
3,0 x 20 mm	●	●		9.20	20,000 Ad.	1,000 Ad.	9.20
3,0 x 25 mm	●	●	●	10.50	20,000 Ad.	1,000 Ad.	10.50
3,0 x 30 mm	●	●		12.10	20,000 Ad.	1,000 Ad.	12.10
3,0 x 35 mm	●	●		13.80	13,000 Ad.	1,000 Ad.	13.80
3,0 x 40 mm	●			16.70	10,000 Ad.	500 Ad.	8.35
3,5 x 13 mm	●			8.05	30,000 Ad.	1,000 Ad.	8.05
3,5 x 16 mm	●		●	8.30	30,000 Ad.	1,000 Ad.	8.30
3,5 x 18 mm	●			9.55	30,000 Ad.	1,000 Ad.	9.55
3,5 x 20 mm	●	●		11.15	20,000 Ad.	1,000 Ad.	11.15
3,5 x 25 mm	●	●	●	11.50	20,000 Ad.	1,000 Ad.	11.50
3,5 x 30 mm	●	●	●	13.60	16,000 Ad.	1,000 Ad.	13.60
3,5 x 35 mm	●	●	●	16.10	13,000 Ad.	1,000 Ad.	16.10
3,5 x 40 mm	●	●		17.85	10,000 Ad.	500 Ad.	8.93
3,5 x 45 mm	●			21.30	8,000 Ad.	500 Ad.	10.65
3,5 x 50 mm	●	●		22.45	6,500 Ad.	500 Ad.	11.23
4,0 x 16 mm	●			12.10	20,000 Ad.	1,000 Ad.	12.10
4,0 x 18 mm	●			12.65	20,000 Ad.	1,000 Ad.	12.65
4,0 x 20 mm	●			13.25	20,000 Ad.	1,000 Ad.	13.25
4,0 x 25 mm	●	●		15.65	15,000 Ad.	500 Ad.	7.83
4,0 x 30 mm	●	●	●	17.70	10,000 Ad.	500 Ad.	8.85
4,0 x 35 mm	●	●	●	20.25	10,000 Ad.	500 Ad.	10.13
4,0 x 40 mm	●	●	●	23.00	8,000 Ad.	500 Ad.	11.50
4,0 x 45 mm	●			25.10	6,500 Ad.	500 Ad.	12.55
4,0 x 50 mm	●	●	●	25.90	6,500 Ad.	500 Ad.	12.95
4,0 x 60 mm	●			34.50	3,200 Ad.	200 Ad.	6.90
4,0 x 70 mm	●			42.00	3,200 Ad.	200 Ad.	8.40
4,5 x 30 mm	●			25.65	10,000 Ad.	500 Ad.	12.83
4,5 x 35 mm	●			28.75	6,000 Ad.	200 Ad.	5.75
4,5 x 40 mm	●			30.50	6,000 Ad.	200 Ad.	6.10
4,5 x 45 mm	●			33.35	4,000 Ad.	200 Ad.	6.67
4,5 x 50 mm	●			36.80	4,000 Ad.	200 Ad.	7.36
4,5 x 60 mm	●			46.00	3,200 Ad.	200 Ad.	9.20
5,0 x 20 mm	●			21.85	10,000 Ad.	500 Ad.	10.93
5,0 x 25 mm	●			25.90	10,000 Ad.	500 Ad.	12.95
5,0 x 30 mm	●			30.50	6,000 Ad.	200 Ad.	6.10
5,0 x 35 mm	●			34.50	6,000 Ad.	200 Ad.	6.90
5,0 x 40 mm	●			36.80	4,000 Ad.	200 Ad.	7.36
5,0 x 45 mm	●			41.40	4,000 Ad.	200 Ad.	8.28
5,0 x 50 mm	●			46.00	4,000 Ad.	200 Ad.	9.20
5,0 x 60 mm	●			51.75	3,200 Ad.	200 Ad.	10.35
5,0 x 70 mm	●			63.25	2,600 Ad.	200 Ad.	12.65
5,0 x 80 mm	●			73.60	2,600 Ad.	200 Ad.	14.72
5,0 x 90 mm	●			96.60	1,300 Ad.	100 Ad.	9.66
5,0 x 100 mm	●			110.40	1,300 Ad.	100 Ad.	11.04
6,0 x 30 mm	●			48.90	4,000 Ad.	200 Ad.	9.78
6,0 x 40 mm	●			58.65	2,600 Ad.	200 Ad.	11.73
6,0 x 50 mm	●			69.00	2,600 Ad.	200 Ad.	13.80
6,0 x 60 mm	●			81.65	2,600 Ad.	200 Ad.	16.33
6,0 x 70 mm	●			92.00	2,000 Ad.	100 Ad.	9.20
6,0 x 80 mm	●			106.95	1,300 Ad.	100 Ad.	10.70
6,0 x 90 mm	●			126.50	1,300 Ad.	100 Ad.	12.65
6,0 x 100 mm	●			132.25	1,300 Ad.	100 Ad.	13.23
6,0 x 120 mm	●			166.75	1,000 Ad.	50 Ad.	8.34
6,0 x 150 mm	●			255.30	650 Ad.	50 Ad.	12.77
6,0 x 200 mm	●			373.75	600 Ad.	50 Ad.	18.69
3,5 x 25 mm Piring Kaplı - Nikel Kaplı				16.70	20,000 Ad.	1,000 Ad.	16.70
4,0 x 30 mm Piring Kaplı - Nikel Kaplı				25.90	10,000 Ad.	500 Ad.	12.95
3,5 x 25 mm Arkalık Vidası - Çinko				19.30	13,000 Ad.	1,000 Ad.	19.30



